

Dell™ Streak 7
User's Manual



Notes, Cautions, and Warnings



NOTE: A NOTE indicates important information that helps you make better use of your device.



CAUTION: A CAUTION indicates potential damage to hardware or loss of data if instructions are not followed.



WARNING: A WARNING indicates a potential for property damage, personal injury, or death.

Information in this document is subject to change without notice.

© 2010 Dell Inc. All rights reserved.

Reproduction of these materials in any manner whatsoever without the written permission of Dell Inc. is strictly forbidden.

Trademarks used in this text: *Dell* and the *DELL* logo are trademarks of Dell Inc.

Adobe Acrobat is a trademark of Adobe Systems Incorporated which may be registered in certain jurisdictions; Microsoft, Windows, Microsoft Office Word, Microsoft Office Excel, and Microsoft Office PowerPoint, are either trademarks or registered trademarks of Microsoft Corporation in the United States and/or other countries.

Other trademarks and trade names may be used in this document to refer to either the entities claiming the marks and names or their products. Dell Inc. disclaims any proprietary interest in trademarks and trade names other than its own.

Contents

1	Dell Streak 7 Tablet Features	7
2	Setting Up Your Dell Streak 7 Tablet	11
	Getting Your Device Ready for Use	11
	Turning On Your Device	13
	Turning Off Your Device	13
	Turning Off the Screen	13
3	Understanding Your Dell Streak 7 Tablet	14
	Out-Of-Box Wizard	14
	Touch Screen	14
	Screen Orientation	17
	Applications, Widgets, and Shortcuts	17
	The Dell™ Stage Desktop	18
	Dell™ Stage Widgets	21
	Status Bar	29
	Quick Buttons	32
	Navigating the Applications	33

4	Using Your Dell Streak 7 Tablet	36
	Managing Contacts	36
	Messaging	39
	Pop-up Menu	45
	Android Keyboard	46
	Google Search	49
	Power Control Widget	50
	Managing Your Device Settings	51
5	Internet	54
	Connecting to the Internet	54
	Browsing the Internet	57
	E-mail	65
	Web Applications	68
	Synchronizing Your Google Data	107
6	Customizing Your Dell Streak 7 Tablet	108
	Display Settings	108
	Sound and Ringtone Settings	109
	Date, Time, and Time Zone	111
	Language Settings	112

7	Protecting Your Dell Streak 7 Tablet	113
	Protect Your Device Data With a Screen Unlock Pattern	113
	Protect Your Device Data With a PIN	115
	Protect Your Device Data With a Password	116
	Protect Your SIM Card With the SIM Lock Password	117
8	Applications	118
	Camera	118
	Copying Files to and From the Device	120
	Bluetooth®	121
	Gallery	124
	Music	126
	Calendar	129
	Clock	132
	Calculator	134
	Sound Recorder	135



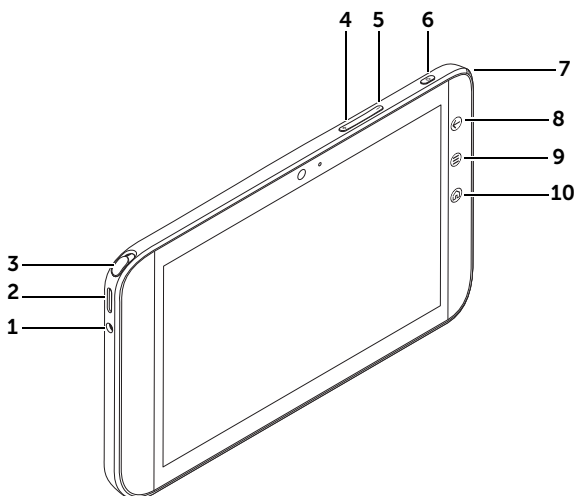

9	Synchronizing Your Dell Streak 7 Tablet and Computer Using Dell Mobile Sync	136
10	Troubleshooting	138
	Starting Your Device in the Safe Mode	140

Dell Streak 7 Tablet Features

This section provides information about the features available on your device.



Buttons/Connectors/Parts	Functionality
1 Headphone connector	Connects to headphones.
2 Speaker	Provides audio output for video and music playback.
3 TV antenna (available on select models only)	Used for improving the reception of television signals.
4 Volume up button	<ul style="list-style-type: none">• Press to increase the media volume by one level.• Press and hold to continuously increase the media volume.
5 Volume down button	<ul style="list-style-type: none">• Press to decrease the media volume by one level.• Press and hold to continuously decrease the media volume.

Buttons/Connectors/Parts	Functionality
6 Power and Sleep/Wake button 	<ul style="list-style-type: none"> • Press and hold to turn on the device. • Press to turn the screen on or off. • While the device is on, press and hold to select one of these options: <ul style="list-style-type: none"> – Silent mode: The device is set to vibrate mode; all sounds are disabled except for alarms. – Airplane mode: Disable all wireless connections. – Power off: Turn off the device.
7 Battery status light	<p>Indicates the battery charge status and pending notifications. The different lights indicate the following:</p> <ul style="list-style-type: none"> • Solid green — Battery is fully charged when connected to power. • Solid amber — Battery is charging. • Solid red — Battery charge is low and the battery is charging. • Blinking red — Battery charge is low. • Blinking green — Indicates pending notifications.
8 Back button 	<p>Touch to return to the previous screen, close a dialog box, menu, or pop-up message, and to dismiss the keyboard.</p>
9 Menu button 	<p>Touch to open or close options menus that display available tools for the current application or actions that you can perform on the current screen.</p>
10 Home button 	<ul style="list-style-type: none"> • Touch to open the central Home screen. • Touch and hold for quick access to the most recently used applications.

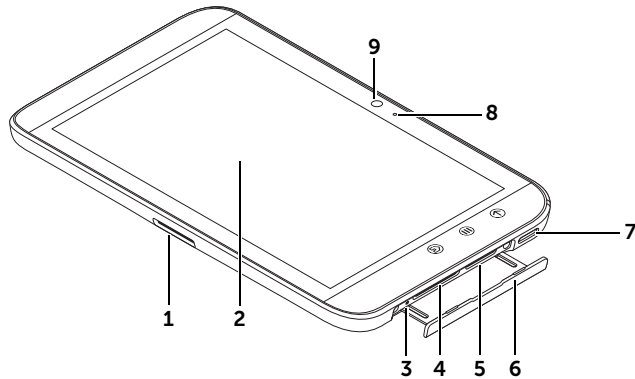

1 30-pin connector	<ul style="list-style-type: none"> • Connects to the supplied USB cable for transferring files to and from a computer. • Connects to the supplied USB cable and USB wall charger adapter to charge the device.
2 Touch screen	Touch the screen to use on-screen controls including buttons, menu items, and the keyboard.
3 Force-power-off button	Push the button to force power off the device.
4 SD card slot	Holds the SD card in place.
5 SIM card slot (available on select models only)	Holds the SIM card in place.
6 Slot door	Provides access to the SIM card and SD card slots.
7 Speaker	Provides audio output for video and music playback.
8 Microphone	Used for making video calls with supportive web applications, such as Skype.
9 Front-facing camera	<ul style="list-style-type: none"> • Used for capturing a front view picture, for example, a self-portrait. • Used for making video calls with supportive web applications, such as Skype.

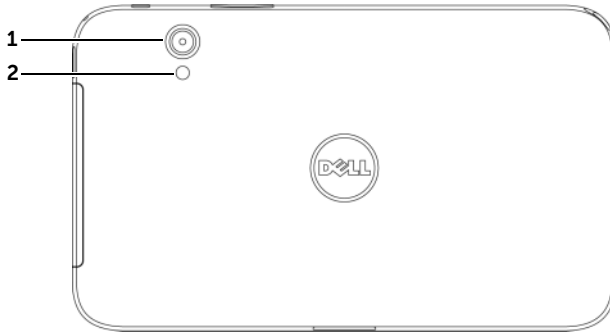

1 Camera lens

Captures pictures and videos.

2 Camera flash

Used for capturing pictures and videos in dimly lit environments.

Setting Up Your Dell Streak 7 Tablet

Getting Your Device Ready for Use

Insert the SIM card

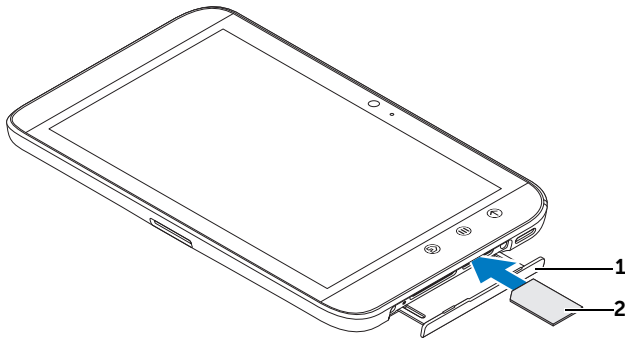

-
- 1 Pull out the slot door.
 - 2 Hold the SIM card with the metal contacts facing down, and follow the SIM card illustration on the slot door label to insert the SIM card into the SIM card slot.
-

Insert the SD card

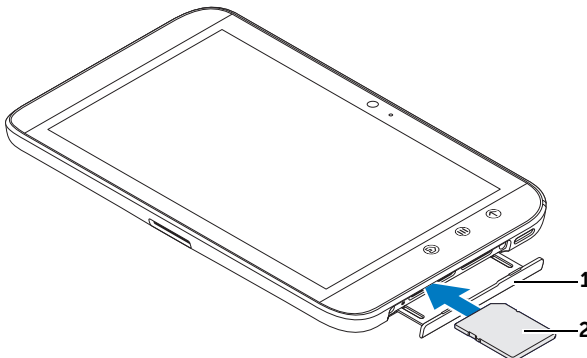

-
- 1 Pull out the slot door.
-

-
- 2 Hold the SD card with the metal contacts facing down, and follow the SD card illustration on the slot door label to insert the SD card into the SD card slot.
-

Charge the battery

 **NOTE:** Charge the battery in an environmental temperature between 0°C and 45°C.

 **NOTE:** The battery is not fully charged when first unpacked.

- 1 Connect the supplied USB cable's 30-pin connector into the 30-pin connector on the device.

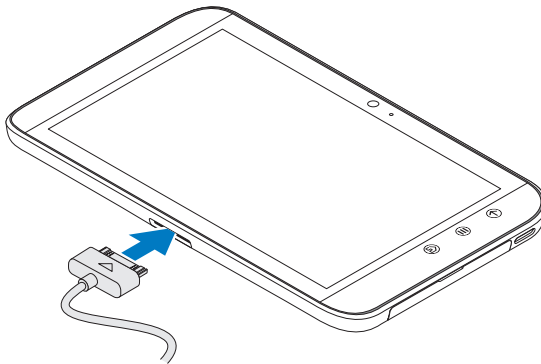



- 2 Connect the cable's USB connector into the supplied USB wall charger adapter.
- 3 Connect the USB wall charger adapter into an electrical outlet and charge the device until the battery is fully charged.

 **NOTE:** When charging the battery by connecting the device to an electrical outlet, the battery requires about 4 hours to be fully charged.

Turning On Your Device

 **NOTE:** Use this device in an environmental temperature between -10°C and 55°C.

- 1 Press and hold the Power and Sleep/Wake button  to turn on your device. The operating system starts up.
- 2 If the screen is locked automatically, flick the  icon up to unlock the screen.
- 3 If your SIM card is locked by a Personal Identification Number (PIN), type the PIN by touching the corresponding number keys using the on-screen keypad. Touch the OK button to confirm your input.



The device is ready for use when the Home screen is displayed.

Turning Off Your Device

- 1 Press and hold the Power and Sleep/Wake button .
- 2 Touch the **Power off** option on the screen.



Turning Off the Screen

If both the device and the screen are on, press the Power and Sleep/Wake button  once to turn off the screen.

 **NOTE:** If the device is on, but the screen is off, press the Power and Sleep/Wake button  once to turn on the screen. For information on unlocking the screen, see "The Screen Lock Wallpaper" on page 35.

Understanding Your Dell Streak 7 Tablet

Out-Of-Box Wizard

To view the on-screen Out-Of-Box Wizard for basic controls of your device, touch the Home button  → the Launcher button  → **welcome**, and follow the instructions to proceed.

You can play the wizard videos to get a quick overview of the device.

At any point during the video, you can touch **CONTINUE** and **PREVIOUS** to go to the next or previous page.

After viewing the last page, touch **DONE** to return to the Home screen.

Touch Screen

Your device has a multi-touch sensitive screen. You can touch the surface of the screen to operate the device.

Finger Gestures

Allows you to:

Touch

Tap gently on the screen with your fingertip.

- Select the items on the screen including options, entries, images, and icons.
- Start applications.
- Press the buttons on the screen.
- Input text using the on-screen keyboard.



Finger Gestures

Allows you to:

Touch and hold

Touch and hold your finger on the screen.

- Enable the moving mode of an item on the Home screen.
- Open the context menu.



Drag

- 1 Touch and hold your finger on an item on the screen.
 - 2 Keeping your finger in contact with the screen, move your fingertip to the desired location.
 - 3 Take your finger off the screen to drop the item in the desired location.
- Move items such as images and icons on the screen.
 - Scroll through Home screens, web pages, lists, entries, photo thumbnails, contacts, and so on.



Finger Gestures

Allows you to:

Flick or swipe

Move your finger in a vertical or horizontal direction on the screen.

Quickly scroll through Home screens, web pages, lists, entries, photo thumbnails, contacts, and so on.



Zoom out

Move two fingers close together on the screen.

Reduce the view of an image or web page (zoom out).



Finger Gestures**Allows you to:****Zoom in**

Move two fingers apart on the screen. Enlarge the view of an image or web page (zoom in).



Screen Orientation

For optimal viewing experience, the screen orientation changes automatically to portrait or landscape format depending on how you hold the device.

 **NOTE:** Applications downloaded from the Android Market may not support automatic screen rotation to portrait or landscape format.

 **NOTE:** To modify the default rotating behavior, open the rotation settings by touching the Home button (🏠) → Menu button (☰) → **Settings** → **Display** → **Auto-rotate screen**.

Applications, Widgets, and Shortcuts

Application — Software which allows you to perform a specific task. Your device is preloaded with a variety of applications, and additional applications can be downloaded from the Android Market.

Widget — A small application which resides on the Home screen and provides quick and easy access to information. For example, the Facebook widget allows you to read posts on your wall and update your status.



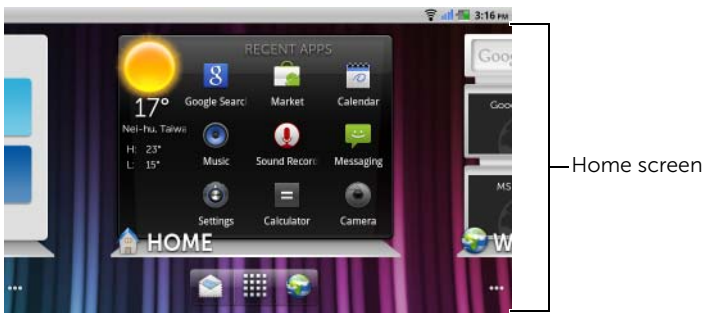

Shortcut — A link that you can create on your Home Screen to provide quicker access to an application or a folder containing contacts or bookmarks.

The Dell™ Stage Desktop

The Dell Stage desktop is composed of multiple screens including the Home screen. The desktop displays predefined Stage widgets, shortcuts, and widgets to give you quick and easy access to frequently-used applications, Twitter or Facebook postings, music, pictures, and more.



You can personalize the Stage desktop by adding your own shortcuts or widgets, or by displaying your favorite picture as the desktop wallpaper.

-  **NOTE:** The desktop screens are fixed, and cannot be added or deleted.
-  **NOTE:** For more information on using Dell Stage widgets, see "Dell™ Stage Widgets" on page 21.
-  **NOTE:** To return to the Home screen from anywhere, touch the Home screen button .

To navigate across the desktop

Flick the desktop horizontally until the desired Home screen is displayed.



To navigate the Home screens using Home screen thumbnails

The Home screen thumbnails act as shortcuts to their individual Home screens. The icon of the thumbnail represents the Stage widget.

- To view the Home screen thumbnails:



- 1 Touch the bottom area on either side of the quick buttons, as illustrated in red.
- 2 Touch and hold the Launcher button  to display the thumbnails.

- To control the Home screens using the thumbnails, either:
 - Touch the corresponding thumbnail to go to the desired screen.



Home screen thumbnails

- To quickly pan through the Home screens, drag your finger horizontally across the thumbnails, until the desired Home screen appears.

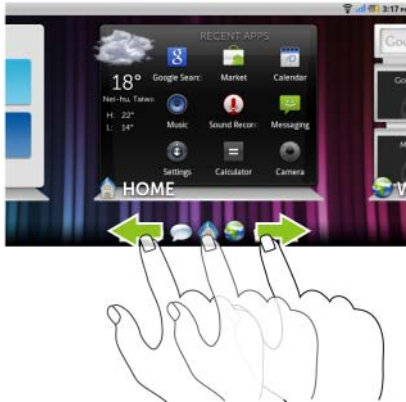

Dell™ Stage Widgets

The Dell™ Stage widgets give you direct access to your most recently used applications, e-mails, photos, music, videos, contacts, Facebook & Twitter updates, and frequently viewed websites.

You can create your own Stage widgets on free Home screens to access the desired items.

Adding a Stage Widget

- 1 Flick to the desktop screen where you want to add a Stage widget.
- 2 To reserve enough space for the widget, remove unwanted items from the screen (see "To remove a Home screen item" on page 28).
- 3 To access the **Add to Home screen** menu, either:
 - Touch and hold an empty area on the home screen.
 - Touch the Menu button  and then touch the **Add** option.
- 4 Touch **Stage Widgets**.
- 5 From the **Select Stage Widget** menu, touch to select the Stage widget you want to add to the screen.

Deleting a Stage Widget

- 1 Touch and hold the Stage widget.
- 2 Drag the widget over the  icon.
- 3 When the widget turns red, release your finger from the screen to delete the widget.

Using Stage Widgets

Touching the label of any Stage Widget opens the supporting application in its default screen. For example, touching the label of the **MUSIC** widget opens the **Music** player in the same manner as it would by touching the **Music** icon in the application drawer.

To use the HOME Stage Widget

From the **HOME** Stage widget, you can touch application shortcuts to access your most recently-used applications.

To use the CONTACTS Stage Widget

From the **CONTACTS** Stage widget, you can view your existing contacts or add a new contact quickly.

- Touch the tile of an existing contact and select the action to proceed with the contact.
- Touch the **ADD** tile to add a new contact.

To use the EMAIL Stage Widget

From the **EMAIL** Stage widget, you can read your e-mails in your e-mail account or compose a new e-mail. If you have not set up an e-mail account, touch **Add an Account** and follow the instructions on the screen to complete your e-mail configuration.

To use the GALLERY Stage Widget

From the **GALLERY** Stage widget, you can view thumbnails of your recent pictures and videos from the **Gallery** application. Touch the thumbnail of a picture or video to view or play it.

To use the MUSIC Stage Widget

From the **MUSIC** Stage widget, you can view the music albums or playlists created on your device.

- Touch a music album to browse for its songs. Touch a song to start playback.
- Touch a playlist to view the playlist you created. Touch a song to start playback.

To use the SOCIAL Stage Widget

The **SOCIAL** Stage widget provides widgets to display the latest postings from your Twitter or Facebook account. To use the Twitter and Facebook widgets, you need to sign in to your Twitter or Facebook account with your e-mail address and password.



NOTE: The **SOCIAL** Stage Widget displays either Facebook or Twitter. If you want to display both applications on the Home screen, add another **SOCIAL** widget to a different screen and sign in to the appropriate service there.

To use the Twitter widget

- 1 Flick through the tweets (Twitter messages) posted by all the authors you follow.
- 2 Touch a tweet to view the other tweets posted by the same author.
- 3 To post your tweet, touch the text box, type your tweet, and then touch the **Update** button. You can also touch the **Update** button to compose and post your tweet.





NOTE: For more information on using Facebook and Twitter, see "Facebook" on page 68 and "Twitter" on page 72.

To use the WEB Stage Widget



The **WEB** Stage widget shows your recently-visited websites and bookmarks. Touch the website you want to visit, or touch **MORE BOOKMARKS** to select a website to visit.

To find information on the Internet, you can also:

- Touch the Google search text box on the top of the widget, enter the name or keyword of the topic you are looking for, and touch the  key on the keyboard or the search icon  on the search box.
- Touch  that appears beside the search box, and say the name or keyword of the topic you are looking for.

Customizing Your Home screen



To add an item to a Home screen

- 1 Touch the Home button .
- 2 Flick to the screen where you want to add the item.
- 3 To access the **Add to Home screen** menu, either:
 - Touch and hold an empty area on the home screen.
 - Touch the Menu button  and then touch the **Add** option.
- 4 Touch the item you want to add on the Home screen:

Items	Steps
Shortcuts Add shortcuts for items that you want to access directly from the Home screen.	Applications: <ol style="list-style-type: none">1 Scroll through the application menu to locate the desired application.2 Touch the desired application to create the shortcut on the current Home screen. Bookmark: <ol style="list-style-type: none">1 Flick through the Bookmarks list to locate the desired bookmark.2 Touch the desired bookmark to create the shortcut on the current Home screen. Contact: <ol style="list-style-type: none">1 Flick through the Contacts entries to locate the desired contact.2 Touch the desired contact entry to create the shortcut on the current Home screen. Direct message: Touch the desired phone number to create the shortcut on the Home screen. You can touch the shortcut to compose and send a message to the number.

Items	Steps
Shortcuts	<p>Directions & Navigation: Create a shortcut that you can touch to open Google Maps and view directions to a location.</p> <ol style="list-style-type: none"> 1 Type your destination in the text box. 2 Choose how you want to get to your destination by touching the driving, public transportation, or walking icon (from left to right). 3 Enter a name for the shortcut. 4 Touch the shortcut icon that you want to use for the shortcut. 5 Touch the Save button. <p>NOTE: For more information on getting directions using Google Maps, see "To get directions" on page 88.</p> <p>Gmail label: Touch to create a desired Gmail label shortcut so that you can access your e-mails with that label from the desktop.</p> <p>Latitude: Create a shortcut that you can touch to open Google Latitude to share locations with your friends and family who have signed in to the service with their Google accounts.</p> <p>Music playlist: Create a Play all or a Recently added shortcut that you can touch to play all songs or recently added songs.</p> <p>Settings:</p> <ol style="list-style-type: none"> 1 Scroll through the settings to locate the desired setting. 2 Touch the desired setting to create the shortcut on the current Home screen, where you can touch the shortcut to access the setting.

Items	Steps
<p>Widgets</p> <p>Add widgets to display active Home screen windows or controls for your favorite applications or web-based services, such as an analog clock, the music player, the Google Quick Search Box, or a calendar showing upcoming events.</p>	<ol style="list-style-type: none"> 1 Touch and hold an empty area on a Home screen. 2 Touch Widgets in the Add to Home screen menu that appears. 3 Flick through the available applications or services to locate the desired application or service. 4 Touch the desired widget to add it on the Home screen.
<p>Folders</p> <p>You can create the following folders:</p> <p>New folder: Add a folder where you can store your Home screen shortcuts.</p> <p>All contacts: Add a shortcut to all your contacts stored in the Contacts application.</p> <p>Bluetooth received: Add a shortcut to access files received through Bluetooth®.</p> <p>Contacts with tablet numbers: Add a shortcut to the contacts with tablet numbers.</p> <p>Facebook Phonebook: Add a shortcut to the Facebook contacts with phone numbers.</p> <p>Starred contacts: Add a shortcut to the contacts marked with a star.</p>	<p>Touch the desired folder to create one on the Home screen.</p> <p>Once the folder is on your Home screen, you can drag and drop an item on top of the folder in order to add it to the folder.</p>

Items	Steps
<p>Wallpapers</p> <p>Change the wallpaper of your Home screen.</p>	<p>Gallery: Open the Gallery application and select a saved picture as a wallpaper, or touch  to open the camera application and capture a picture that you can set as a wallpaper.</p> <ol style="list-style-type: none"> 1 Touch a picture category from your collection, such as Camera, downloaded, and so on. 2 Flick the picture thumbnails horizontally to locate the desired picture. 3 Touch the picture to display it. 4 To cut a portion of the picture as the wallpaper, move the crop frame and drag the angles to locate the desired part. 5 Touch the Save button to set the wallpaper. <p>Live wallpapers: Select an animated and interactive wallpaper.</p> <p>Wallpapers: Flick to or touch a picture thumbnail to display a picture, then touch Set wallpaper to set it as a wallpaper.</p> <p>NOTE: You can also touch the Home button  → the Menu button  → Wallpaper to change your Home screen wallpaper.</p>

To add an application shortcut from the main applications view

- 1 Touch the Launcher button  at the bottom of the screen to enter the main applications view.
- 2 On the main applications view, touch and hold a desired application and drag it onto the current Home screen. The application's icon appears on the Home screen.

To move a Home screen item

- 1 Touch and hold the item you want to reposition until it magnifies and becomes movable. The device vibrates to indicate that the item's moving mode is activated.



NOTE: To disable the item's moving mode, release the item.

- 2 With your finger remaining in contact with the item on the screen, drag the item to another location on the screen.
- 3 Release the item in the desired location.

To remove a Home screen item

- 1 Touch and hold an item such as a widget, shortcut, or folder that you want to remove, until it magnifies and becomes movable.
- 2 Drag the item onto the top of the Trash icon , and when the item turns red release it.

To open a Home screen folder

- 1 Touch the folder to open a panel displaying the contents of the folder.
- 2 Touch the desired application shortcut to run the application.

To close a Home screen folder

Touch the Close icon  to close the panel.

To move a Home screen shortcut into a folder

- 1 Touch and hold a shortcut to make it movable.
- 2 Drag and drop the shortcut into a folder on the Home screen.

 **NOTE:** Widgets and folders cannot be moved inside a folder.

To remove a Home screen shortcut from a folder

- 1 Touch a folder on the Home screen to view the contents.
- 2 Touch and hold a shortcut to make it movable. The shortcut pops out and the folder closes automatically.
- 3 Drag the shortcut to another location on the Home screen.

To rename a Home screen folder

- 1 Touch a folder to open the folder panel.
- 2 Touch and hold the top area of the folder panel
, until the **Rename folder** menu opens.
- 3 Touch the **Folder name** text box to type the name using the on-screen keyboard.
- 4 Touch **OK** to confirm.

Status Bar





















The status bar at the top of the Home screen displays the notification, status, and time areas.









- 1 Notification area
 - The notification area displays notification icons to inform you of new e-mail, messages, and so on.
 - Touch and drag down the status bar to view the notifications listed in the order of arrival time, and then touch a notification to view the desired message, and e-mail.



















<p>2 Status area</p>	<ul style="list-style-type: none"> • Displays status icons to show the current state of your device, such as battery power, charging progress, alarms set, network connections, and so on. • Touch and drag down the status bar to view the information regarding the carrier currently in use, remaining battery charge, and so on.
<p>3 Time area</p>	<p>Displays the current time.</p>

The status area may also display some of the following icons:

 Alarm is set	 UMTS data network is connected (only available for carrier-specific versions)
 Battery status — 100% full	 UMTS data network is in use (only available for carrier-specific versions)
 Battery is low and needs to be charged	 HSPA+ data network is connected (only available for carrier-specific versions)
 Battery is extremely low and needs to be charged immediately	 HSPA+ data network is in use (only available for carrier-specific versions)
 Battery is charging	 GPRS data network is connected
 Vibrate mode is enabled	 GPRS data network is in use
 Silent mode is enabled	 EDGE data network is connected
 Signal strength — strong	 EDGE data network is in use
 No signal	 Roaming signal strength — strong
 Airplane mode is enabled	 Connected to a Wi-Fi network

 Ongoing data synchronization	 Bluetooth is enabled
 GPS satellites function is enabled	 Connected to a new Bluetooth device
 Receiving location data from GPS satellites	 No SIM card is inserted
 The headphone is connected	

The notification area may also display some of the following icons:

 Problem with sign-in or sync	 New e-mail message
 SD card is full	 Download in progress
 A Wi-Fi network is found	 Download complete
 USB cable is connected	 Application update available
 Some notifications not displayed	 The SD card is safe to remove
 New Gmail message	 Preparing the SD card
 New SMS/MMS	 Song is playing
 Problem with SMS/MMS delivery	 New Google Talk message
 New voicemail	 Upcoming calendar event

Quick Buttons

The quick buttons at the bottom of the Home screen allow you to quickly access the application drawer and some main functions.



1 Home screen dots

- Touch the dots  at the bottom left of the screen to display the Home screen thumbnails.
- Double-tap the dots at the bottom left of the screen to move to the first Home screen.



2 Email button



Touch the Email button  to open the **Email** application. For more information on using Email, see "E-mail" on page 65.

3 Launcher button



- Touch the Launcher button  to display the application drawer.
- Touch and hold the Launcher button  to display the Home screen thumbnails.

4 Browser button



Touch the Browser button  to open the **Browser** application.

5 Home screen dots

- Touch the dots  at the bottom right of the screen to display the Home screen thumbnails.
 - Double-tap the dots at the bottom right of the screen to move to the last Home screen.
-



Navigating the Applications

You can find applications available on your device in these screen elements:

Application Drawer

The application drawer can be accessed from any home screen and contains all of the applications installed on the device, including those you have downloaded from the Android Market.



To open the application drawer

- 1 Touch the Home button  to display the default Home screen on the desktop.
- 2 From any of the desktop Home screens, you can:
 - Drag up in the lower area of the screen.
 - Touch the Launcher button .

To navigate pages of applications

Flick the applications drawer horizontally and touch an application to run it.

To close the application drawer

- Drag down anywhere within the application drawer.
- To return to the default Home screen, touch .
- To return to the current Home screen, touch .

Application Shortcuts

To quickly launch applications on the Home screen, you can add shortcuts for frequently-used applications to the Home screen or to the folder that you created on the Home screen. For more information, see "Customizing Your Home screen" on page 24.

To open an application using the application shortcuts

- 1 Touch the Home button .
- 2 If the desired application shortcut displays on the Home screen, touch the shortcut to run the application.
If the desired application is stored in a folder on the Home screen, touch the folder to display the contents of the folder, and then touch the desired application shortcut.

Recent Applications

To open a recently used application

- 1 Touch and hold the Home button  to view the recently used applications, or create the **HOME** Stage Widget on the Home screen which contains the most recently used applications (see "Adding a Stage Widget" on page 21).
- 2 Touch the desired application shortcut to run the application.

The Screen Lock Wallpaper



You can set the display to turn off automatically after a timeout period of inactivity, or turn it off manually by pressing the power button .

When you press the power button  to wake up the display, the screen lock wallpaper appears to help prevent unintentional touch of the screen.



-
- 1 Drag or flick this button downward to enable or disable the vibration mode.
 - 2 Drag or flick this button upward to unlock the screen.
-



NOTE: To set the duration the screen remains on before turning off after the last operation, touch the Home button  → Menu button  → **Settings** → **Display** → **Screen timeout**.

Using Your Dell Streak 7 Tablet

Managing Contacts

To view and manage your contacts, touch  → **Contacts** .

To add a new contact

- 1 Touch the Menu button  → **New contact**.
- 2 Select the account where you want to add this contact, such as your Gmail account.

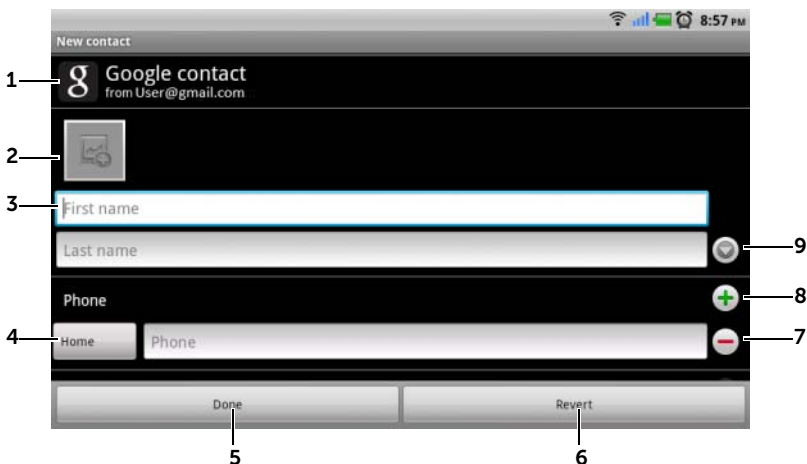

- 1 This area shows the account in which the new contact is stored.
- 2 Touch to take a photo or select a photo from the **Gallery** application to use as the contact's visual caller ID.
- 3 Enter the contact information using the on-screen keyboard. Scroll the screen to find more items to fill.
- 4 Touch to replace a default information label with another label that you can choose from the **Select label** list. For example, you can change the label from **Mobile** phone number to **Home** phone number.
- 5 Touch **Done** to save the new contact to your Contacts list.

-
- 6 Touch **Revert** to return to your Contacts list.

 - 7 Touch to remove an item from the current information category.



 - 8 Touch to add a new item to the current information category. For example, you can add a second phone number.

 - 9 Touch to fill more information about the contact.
-

To find a contact

- 1 To locate a contact, you can either:
 - Flick the contact list until you find the contact.
 - Touch the Menu button  → **Search**, and then type either the contact's full name or only the first letters of it into the **Search contacts** text box. The screen displays the matching contacts.
- 2 Once the contact is located, touch the contact's entry to view the contact's details.

To e-mail or send a message to a contact

- 1 On the Contacts list, find a desired contact.
- 2 Do one of the following:
 - Touch the photo icon of the contact. The icons that represent the actions you can do such as e-mail  or address search on Maps  appear. Touch the action you want to perform.
 - Touch the contact entry to view the contact details, and then touch **Email** to send e-mail using the e-mail accounts you have set up on your device, or touch  to send a message.

To edit or share a contact

- 1 On the Contacts list, find the desired contact.
- 2 Touch the contact entry to view the contact details.
- 3 Touch the Menu button , and then touch **Edit contact** to edit the contact details, or touch **Share** to share the contact information with your friends through e-mail or Bluetooth.



NOTE: For information about composing and sending messages, see "Messaging" on page 39. For information about using the e-mail applications, see "Gmail" on page 76 and "E-mail" on page 65.

Contacts settings



In **Contacts** , touch the Menu button .

Display options

Choose from which accounts you want to display the contacts, or set your device to only display the contacts who have phone numbers.

Accounts

NOTE: If you want to synchronize individual data manually, clear **Auto-sync**, and then from your account, touch a data item to start synchronization of that data.

While data is syncing, the sync icon  appears on the status bar, and the sync icon  appears on the option of the data being synced.

Contacts stored on your device can be synchronized with a computer using Dell Mobile Sync; contacts stored on your personal e-mail account such as Gmail can be synchronized through an Internet connection.

- To select the data to synchronize:
 - 1 Select **Background data** to make all the sync options available.
 - 2 Select **Auto-sync** to let the device automatically synchronize the selected data in your e-mail account, which may include Contacts, Gmail, Calendar, Picasa Web Albums, or Twitter data.
 - To select the data to sync from your e-mail account:
 - 1 Touch your e-mail account to open the **Data & synchronization** list.
 - 2 Select the data that you want the device to synchronize automatically, such as **Sync Contacts, Sync Gmail, Sync Calendar, Sync Picasa Web Albums, and Sync Twitter data.**
-

Import/Export

You can import contacts from your SIM/SD card to your device, export contacts from your device to your SD card, and share visible contacts using Bluetooth or Gmail.

Messaging

To compose, send, and read text (SMS) or multimedia (MMS) messages, touch  → **Messaging** . The Messaging screen opens with a list of messages or message threads representing all the received, sent, and draft messages.

 **NOTE:** For information about the message thread, see "Receiving text and multimedia messages" on page 43.

To compose and send a text message

- 1 On the Messaging screen, touch the **New message** thread. The composer screen opens.
- 2 In the **To** field, type the mobile phone number or the contact name of the recipient. As you type a phone number or contact name, matching contacts with their mobile numbers appear below the **To** field. Touch a matched contact to enter the contact's mobile number, or continue typing the desired phone number.
- 3 Repeat step 2 to enter more mobile numbers if you want to send the message to multiple mobile phone users.
- 4 If you want to add a subject line to the message, touch the Menu button  → **Add subject**.
- 5 Touch the **Type to compose** text field to start composing your message.
- 6 Touch the **Send** button to send the text message.
- 7 To start a text conversation similar to online instant messaging, you can continue to compose and send messages to the same recipient(s). All of the sent and received messages between you and recipient(s) appear in the form of chat logs.

To compose and send a multimedia message

- 1 In the **To** field, type the recipient's mobile phone number, e-mail address, or contact name. Matching contacts with their mobile numbers or e-mail addresses appear below the **To** field. Touch a matched contact, or continue typing the desired phone number or e-mail address.
- 2 Touch the **Type to compose** text field to start composing your message.
- 3 While editing your message, you can touch the Menu button  **Attach** to insert media items into the message. See the following table for more information.
- 4 When you have completed editing the multimedia message, touch the **Send** button to send the message.

You can attach any of the following items to a multimedia message:

Picture	Open the Gallery application and touch a picture file to attach it to your message.
Capture picture	Open the Camera application to capture a picture, and then attach it to your message. For more information about the Camera application, see "Camera" on page 118.
Video	Open the Gallery application and touch a video clip to attach it to your message.
Capture video	Open the Camcorder application to capture a video clip, and then attach it to your message. For more information about the Camcorder application, see "Camera" on page 118.
Audio	Open the Select music track menu. Touch a desired audio file, and then touch OK to attach the file to your message.



Ringtone

Open the **Select audio** menu. Touch a desired preloaded ringtone, and then touch **OK** to attach it to your message.

You can also manually copy new ringtones to the SD card and attach a ringtone to your MMS. To do so, follow the steps below:

- 1 Create a folder named Ringtones in the SD card.
- 2 Open the Ringtones folder.
- 3 Copy the ringtone you want to attach to your MMS into the Ringtones folder.
- 4 On the MMS composer screen, touch the Menu button  → **Attach** → **Ringtone**.
- 5 Select the ringtone to attach it to your MMS.



Record audio

- Open the **Music** application and select a music file from the list.
 - Open the **Sound Recorder** application to record an audio clip:
 - Touch  to start recording.
 - Touch  to stop recording.
 - Touch  to listen to the recording.
 - Touch **Use this recording** to attach the recording to your message.
-



Slideshow

Open the **Edit slideshow** screen to create a slide show and attach it to your message.

- 1 Touch **Add slide** to create new slides.
- 2 Touch a created slide such as **Slide 1** to open the slideshow editor screen.
- 3 Touch **Add picture**, and then select the picture you want to add to the slide.
- 4 You can touch the text field at the bottom of the screen to compose a caption for the displayed slide.
- 5 Touch the Menu button  to preview the slide, remove the picture, add a music to the current slide, add a new slide, or change the slide duration or the text and picture layout.

- 6 When editing multiple slides, touch  to edit the next slide; touch  to return to the previous slide.

NOTE: You can create a slideshow of up to ten slides.

- 7 To replace a picture, on the slideshow editor screen, touch the **Replace picture** button and select a new picture to replace. To remove the current slide, touch the **Remove Slide** button. To preview the slideshow, touch the **Preview** button.
 - 8 When complete, touch the **Done** button to attach the slideshow to your message.
 - 9 On the message composer screen, touch the slideshow attachment icon  to play back the slide show; touch **Edit** to modify the slideshow.
 - 10 To remove the slideshow attachment from your message, touch **Edit** → Menu button  → **Discard slideshow**.
-

Receiving text and multimedia messages

Depending on your notification settings, the device rings, vibrates, or displays a message briefly in the status bar as a new text or multimedia message is received.



A new message icon  appears and stays in the notifications area of the status bar to remind you of a new message.



NOTE: To alter the notification settings for new messages, in the Messaging application, touch the Menu button  → **Settings** → **Notification settings**. You can then decide whether to display a text notification in the status bar when a new message arrives, select a ringtone that rings on the arrival of a new message, or let the device vibrate to notify a new message.

Text and multimedia messages that are sent to and received from the same contact or a number are grouped into message threads similar to text conversations of an online chat. You can see all of the messages exchanged between you and the contact. Message threads are listed according to when they are sent or received, with the latest message at the top.

To read a text message

- Touch and drag down the status bar where the new message icon  is displayed. A list of notifications is displayed. Touch a new message notification to open and read the message.
- Touch  → **Messaging**  to open the message list, and then touch a text message or message thread to open and read it.

If the message includes a:

- Website link — touch the link to open the **Browser** application and visit the website.
- E-mail address — touch the e-mail address to open the **Email/Gmail** application and compose an e-mail to send to the address.



To forward the message

- 1 Touch and hold the message. The **Message options** menu pops up.
- 2 Select **Forward** to forward the message.

To view a multimedia message

- 1 Touch and drag down the status bar where the new message icon  is displayed. A list of notifications opens. Touch a new message notification to open the message.

Or

Touch  → **Messaging**  to open the message list, and then touch a multimedia message or message thread to open the message.

- 2 Touch the thumbnail of the attached picture to display the picture; touch the **Play** button  to play the attached video.



NOTE: Touch the **Download** button, to manually download the media file in the message.



NOTE: To save the attached media item to your SD card, touch and hold the message until the **Message options** menu opens. Touch **Copy attached to SD card**.

To reply to a text or multimedia message

- 1 Touch a message or message thread to open it.
- 2 Type your reply message into the **Type to compose** text field.
- 3 Touch **Send** to send your message to the sender.

To delete a message or a message thread

- 1 In the Messaging list, touch and hold the message thread that you want to delete.
- 2 To delete the entire thread, touch **Delete thread** and then touch **Delete** to confirm deletion.
To delete a message within a thread, touch and hold the message to delete, and then touch **Delete message** on the Message options menu. Touch **Delete** to confirm deletion.



NOTE: To delete all messages in the Messaging list, touch the Menu button  → **Delete threads**.



To edit message settings

In the Message application, touch the Menu button  → **Settings**. Follow the instructions on the screen to change the text or multimedia message settings.

Pop-up Menu

Touch the Menu button  to open or close the pop-up menu that lists available options for the current application, or actions that you can perform on the current screen.

To select an option or item on the pop-up menu

- 1 Touch the Menu button  to open the pop-up menu.
- 2 Touch the desired item on the pop-up menu.
- 3 Touch the Menu button  again to close the pop-up menu.

Android Keyboard

You can type text using the Android on-screen keyboard. The keyboard automatically rotates to either the portrait or landscape mode based on the device orientation.

To open the Android keyboard

Touch a text box, or touch and hold the Menu button .

To close the keyboard

Touch the Back button  or touch and hold the Menu button .



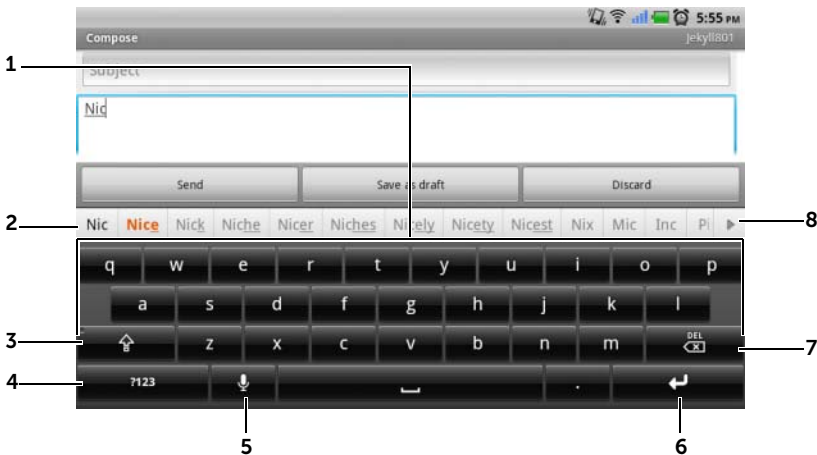

Keyboard controls for composing an e-mail



-
- Touch to type letters into the text box where the cursor appears.
 - Touch and hold to type accented letters for applicable languages.
 - Based on the letters being typed, the keyboard shows suggested words along the top of the keyboard with the most probable word highlighted in color.
 - You can touch a suggested word to enter it into the text box.
-

-
- 3
 - Touch once to show the uppercase keyboard for typing a capital letter.
 - Touch twice to enable the Caps Lock mode.
 - Touch to change back to the lowercase keyboard.
-
- 4
 - Touch to show the keyboard for typing numbers, punctuation marks, and symbols other than the period.
 - Touch to switch back to the alphabet keyboard.
 - Touch and hold to select the following option:
 - **Android keyboard settings:** Configure the keyboard settings.
-
- 5 Touch to use voice input. Say the words you want to enter in the microphone. The device enters the words that it can recognize from your voice.
-
- 6 Touch to enter a line feed.
-
- 7
 - Touch to delete a typed character, symbol, or a space.
 - Touch and hold to quickly delete typed text.
-
- 8
 - Touch  to see more suggested words.
-

To configure the keyboard settings

- 1 Touch the Home button  → Menu button  → **Settings** → **Language & keyboard** → **Android keyboard**. Or from the Android keyboard, touch and hold  to open the **Android keyboard** context menu → **Android keyboard settings**.
- 2 To enable a setting, touch the setting option to select the check box ; to disable a setting, touch the setting option to clear the check box .

Available keyboard settings

Vibrate on keypress	The device vibrates when you touch a key.
Sound on keypress	The device beeps when you touch a key.



NOTE: To activate this item, you also need to select **Settings** → **Sound** → **Audible selection**.

Auto-capitalization	The first letter of the word in a new sentence is capitalized.
Voice input	Turn on the microphone to enable voice input for the main keyboard or symbols keyboard.
Word suggestion settings	
Quick fixes	Mark and correct wrong spellings and typos.
Show suggestions	Show suggested words as you type.
Auto-complete	Touching the space bar or a punctuation key automatically inserts a highlighted word suggestion.



Create your personal dictionary

The keyboard displays suggested words as you type using the default dictionary. You can create a personal dictionary to include words not found in the main dictionary. Word suggestions also appear from your personal dictionary, if you have created it.

To add a word to the dictionary

- 1 Touch the Home button  → Menu button  → **Settings** → **Language & keyboard** → **User dictionary**.
- 2 Touch the Menu button  → **Add**.
- 3 Type a desired word into the **Add to dictionary** text box.
- 4 Touch **OK**.

To edit a word in the dictionary

- 1 Touch the Home button  → Menu button  → **Settings** → **Language & keyboard** → **User dictionary**.
- 2 Touch a desired word.
- 3 Touch **Edit**.
- 4 Edit the spelling of the word in the **Edit word** text box.
- 5 Touch **OK**.

To delete a word from the dictionary

- 1 Touch the Home button (🏠) → Menu button (☰) → **Settings** → **Language & keyboard** → **User dictionary**.
- 2 Touch the word to delete.
- 3 Touch **Delete**.



Google Search

You can use the Google Quick Search Box to find websites and information on Google, applications installed on your device or available from Android Market, and contacts stored in your Contacts list.

To search by typing

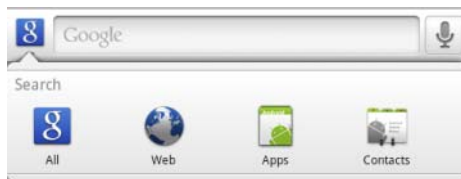
- 1 From the Google Search widget you created on the Home screen, touch  to select the type of your search: **All**, **Web**, **Apps** or **Contacts**.





- 2 Touch the Google Quick Search Box. The on-screen keyboard opens.
- 3 Type a keyword or text into the box using the keyboard. As you type, the search results that fully or partially match the text being typed appear below the search box.
- 4 Scroll the listed search results and touch the desired result. If you only want to view matching web links on Google, either touch the  key on the keyboard or the search icon  on the search box.
- 5 The matching application or the browser with matching web links opens.

- 6 Touch the desired link if you want to view a web page.

To search by voice

- 1 Touch  that appears beside the search box.
- 2 Say the name or keyword of the item you want to search.
- 3 The browser with matching web links opens.

 **NOTE:** You can also access the Voice Search function by touching the Launcher button  → **Voice Search** .

Power Control Widget

 **NOTE:** To use the Power Control widget, you need to add it on the Home screen of your device. For information on adding widgets to the Home screen, see "Customizing Your Home screen" on page 24.



 **NOTE:** To conserve battery charge, you may choose to disable one or more of these modes when not in use.





-
- 1 Indicates if the appropriate mode is enabled or disabled.
 - 2 Touch to enable or disable Wi-Fi connection.
 - 3 Touch to enable or disable Bluetooth®.
 - 4 Touch to enable or disable the Use GPS satellites mode, which allows you to pinpoint locations down to the street-level. This mode requires a clear view of the sky and consumes more battery power.
 - 5 Touch to enable or disable the Auto-sync mode, which lets your device automatically sync your Gmail, Twitter, Facebook, Outlook data, or the data from other accounts you set up on the device.
 - 6 Touch repeatedly to adjust the brightness of your display backlight.
-

Managing Your Device Settings



To check storage spaces

Touch the Home button  → Menu button  → **Settings** → **SD card & Device storage**. The screen displays the total and available space on the device and on the SD card.

To erase unwanted application data to free storage space

- 1 Touch the Home button  → Menu button  → **Settings** → **Applications** → **Manage applications**.
- 2 From the Manage applications list, touch the application whose cache or data you want to remove.
- 3 In the **Application info** screen, touch **Clear data** under **Storage** to erase unwanted application data; touch **Clear cache** under **Cache** to erase unwanted cache.

To format the SD card

- 1 Touch the Home button  → Menu button  → **Settings** → **SD card & Device storage**.
- 2 Touch **Unmount External SD card** to enable the **Format SD card** option.

 **CAUTION:** Formatting a SD card erases all data and downloaded applications stored on it. Ensure that you back up the data that you require before formatting your SD card.

- 3 Touch **Format External SD card** → **Format SD card** button.

To remove the SD card safely

 **CAUTION:** Removing the SD card while the device is working may cause data loss or result in application errors.

 **CAUTION:** It is strongly recommended that you unmount the SD card before removing it.

- 1 Touch the Home button (🏠) → Menu button (☰) → **Settings** → **SD card & Device storage**.
- 2 Touch **Unmount External SD card**.
- 3 Press and hold the Power and Sleep/Wake button (🔌) and then touch the **Power off** option to turn off the device.
- 4 Pull out the slot door and then remove the SD card from your device as illustrated.

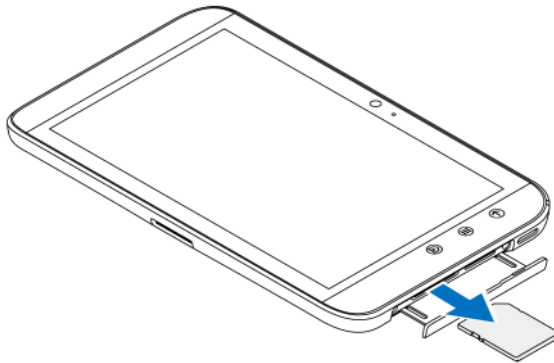

To erase all data from your device



CAUTION: The following steps will erase all the data including your Google account and downloaded applications from your device. Ensure that you back up all the required data before you proceed.

- 1 Touch the Home button (🏠) → Menu button (☰) → **Settings** → **Privacy** → **Factory data reset**.

- 2 Touch **Reset tablet**.



NOTE: You must draw your screen unlock pattern if it is enabled.

- 3 Touch **Erase everything** after you read the warning.

To force power off your device

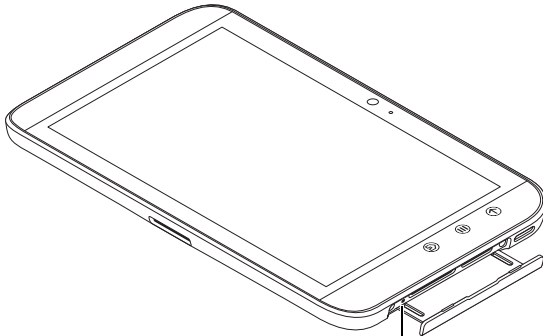

Force-power-off button

- 1 Pull out the slot door.
- 2 Push the force-power-off button using a paper clip or other similar pointed objects.
- 3 Press and hold the Power and Sleep/Wake button  to turn on your device.

Internet

Connecting to the Internet

To browse the web and access web-based utilities such as instant messaging, one of the following data networking connections must be available:





- GPRS
- EDGE
- 3G
- 4G
- HSPA
- Wi-Fi

GPRS/EDGE/3G/4G/HSPA

To connect to the Internet using GPRS, EDGE, 3G, 4G, or HSPA

Your device is configured with the GPRS, EDGE, 3G, 4G, or HSPA network available with the service provider of the SIM card installed in your device. However, this is only limited to text messaging. If a Wi-Fi connection is currently available, the device automatically uses the Wi-Fi connection to access the Internet. The Internet connection through GPRS, EDGE, 3G, 4G, or HSPA becomes temporarily inactive, until the Wi-Fi connection ends.

If you want to connect to the Internet using a GPRS, EDGE, 3G, 4G, or HSPA data network:



- 1 Touch the Home button  → Menu button  → **Settings** → **Wireless & networks**, then touch **Wi-Fi** to disable it.
- 2 Touch the Home button  → Menu button  → **Settings** → **Wireless & networks** → **Mobile networks**, then touch **Data enabled** to enable it.





NOTE: Depending on whether a GPRS, EDGE, 3G, 4G, or HSPA network is currently in use, a corresponding data network icon appears on the status bar after a data connection is established. For information about the data network icons, see "Status Bar" on page 29.

You can set the device to search for available networks if you are outside your home network or want to register to a different network.

To manually select a new network

- 1 Touch the Home button  → Menu button  → **Settings** → **Wireless & networks** → **Mobile networks** → **Network operators** → **Search networks**. The list of networks currently available is displayed.
- 2 Touch to select a network from the network list.

To automatically select a new network

Touch the Home button  → Menu button  → **Settings** → **Wireless & networks** → **Mobile networks** → **Network operators** → **Select automatically**.

Wi-Fi



You can connect your device to the Internet using Wi-Fi.

To connect to a Wi-Fi network, you need access to a wireless point or "hotspot" within a distance of up to 300 feet (100 meters).



NOTE: The range and quality of the Wi-Fi signal is affected by the number of connected devices, infrastructure, and objects through which the signal is transmitted.

To turn on Wi-Fi and connect to a network

- 1 Touch the Home button  → Menu button  → **Settings** → **Wireless & networks** → **Wi-Fi** to select the Wi-Fi check box. The device scans for available wireless networks.
- 2 Touch **Wi-Fi settings**. The network names and security settings (Open network or Secured with WEP/WPA/WPA2/WPS) of discovered Wi-Fi networks display in the **Wi-Fi networks** list.

- 3 Flick the list and touch to select a Wi-Fi network you want to connect to.
- 4 Enter a password (if necessary), then touch **Connect** to connect to the Wi-Fi network.



NOTE: To connect to a network protected by Wired Equivalent Privacy (WEP), Wi-Fi Protected Access (WPA), WPA2, or Wireless Protected Setup (WPS), you must enter the WEP/WPA/WPA2/WPS security key to obtain authorized access to the network. The next time your device connects to a previously accessed secured wireless network, you will not be asked to enter the WEP/WPA/WPA2/WPS key again, unless you reset your device to its factory default settings.



NOTE: Your device has the ability to maintain a constant Internet connection through Wi-Fi or data networks (GPRS, EDGE, 3G, 4G, or HSPA). However, Wi-Fi connection has priority over mobile network connection if both are available.

To check the current Wi-Fi network connection

From the status bar:



When your device is connected to a wireless network, the Wi-Fi icon



in the status bar indicates the signal strength (number of bands that light up). If **Wireless & networks** → **Wi-Fi settings** → **Network**

notification is enabled, the  icon appears in the status bar as the device discovers an accessible Wi-Fi network within range.



From the Wi-Fi network:

- 1 Touch the Home button  → Menu button  → **Settings** → **Wireless & networks** → **Wi-Fi settings**.
- 2 Touch the Wi-Fi network that the device is currently connected to (labeled **Connected**). A window opens displaying the Wi-Fi network's name, status, security info, signal strength, link speed, and IP address.



NOTE: If you want to disconnect the Wi-Fi network from your device, touch **Forget** on this window. You will need to configure the Wi-Fi settings again if you want to restore connection to this wireless network.

To connect to another Wi-Fi network

- 1 Touch the Home button  → Menu button  → **Settings** → **Wireless & networks** → **Wi-Fi settings**. The detected Wi-Fi networks are displayed in the **Wi-Fi networks** list.



NOTE: To start a new search for available Wi-Fi networks, on the **Wi-Fi settings** screen, touch the Menu button  → **Scan**.



- 2 Flick through the Wi-Fi networks list and touch the name of the network you want to connect to.



NOTE: If the wireless network you want to connect to is not in the list of detected networks, flick to the bottom of the list to touch **Add Wi-Fi network**. Enter the Wi-Fi network settings, and then touch **Save**.



Disable all Connections Using the Airplane Mode

Selecting the Airplane mode disables all mobile and Wi-Fi connections. This feature is useful when wireless connectivity is strictly prohibited, such as on an airplane.

Touch the Home button  → Menu button  → **Settings** → **Wireless & networks** → **Airplane mode** to enable or disable the Airplane mode.

Browsing the Internet

To open the browser

Touch the Browser button  or touch the Launcher button  →

Browser 



To use the browser controls bar



- 1 Touch the web page address field and type the address of the web page you want to go to.

-
- 2 Touch to view bookmarks, most visited web pages, and browsing history.
-

To go to a web page

- 1 On the browser screen, touch the web page address field on the screen.
- 2 Type the web page address using the on-screen keyboard. As you type the address, matching web page addresses appear.
- 3 Touch an address displayed on the screen to go directly to that web page, or complete typing the web page address and then touch either the  key on the keyboard or  on the browser controls bar.

To set up your home page

To manually enter a home page:

- 1 Touch the Menu button  → **More** → **Settings** → **Set home page**.
- 2 Enter the address of the website you want to use as your home page and then touch **OK**.

To set the current page as the home page:

- 1 Go to the web page that you want to set as the home page.
- 2 Touch the Menu button  → **More** → **Settings** → **Set home page**.
- 3 Touch **Use current page** → **OK**.

To select a home page from bookmarks:

- 1 Touch  from the browser control bar to call up the lists of bookmarks, most visited sites, and browsing history.
- 2 Touch and hold a desired bookmark to call up the commands menu → **Set as homepage**.

Viewing Web Pages

To navigate on a web page

Flick your finger horizontally or vertically on the screen to scroll and view desired areas of a web page.

To zoom in on a web page

Pinch-out a desired area of a web page by moving two fingers apart on the screen.



To zoom out on a web page

Pinch-in a desired area of a web page by bringing two fingers closer together on the screen.



NOTE: You can also double-tap the desired area of a web page to switch between the zoom-in and zoom-out views of the area.

To view the next or previous page



Touch the back button  to view the previous page; touch Menu button  → **More** → **Forward** to view the next page.

To open a new window





Touch the Menu button  → **New window**. A new browser window opens and displays the home page.

To switch between browser windows

You can open multiple browser windows to easily switch from one web page to another.

- 1 On a browser window, touch the Menu button  → **Windows**.
- 2 Touch the web address of a desired web page. The window opens displaying the page in full screen.
- 3 To close a browser window, touch  on the browser window.

To find text within a web page

- 1 When viewing a web page, touch the Menu button  → **More** → **Find on page**.
 - 2 Type the search item in the search bar.
 - 3 Touch  or  to go to the previous or next matching item.
-  **NOTE:** Touch  to close the search bar.

To copy text on a web page

You can copy and paste text from a web page to your e-mail or text messages.

- 1 Go to the web page from where you want copy the text.
- 2 Locate the text you want to copy and then touch the Menu button  → **More** → **Select text**.
- 3 Position your finger at the start of the text you want to copy and then drag to the end of the text you want to copy. The copied text is highlighted in pink.
- 4 Release your finger from the screen.
- 5 To paste text on an e-mail or text message, touch and hold the text field on a message or e-mail screen and then touch **Paste** on the context menu.



Using Web Links, History, and Downloads

To select a link on a web page

Move to a link you want on a web page. The link is framed by an orange box when you touch it.

Link type	Functionality
Web page address	<ul style="list-style-type: none">• Touch the link to open the web page.• Touch and hold the link to open a context menu that allows you to open, bookmark, and save the link, copy the link of the web page to the clipboard, or share the link through Bluetooth, e-mail, Facebook, text messaging, or Twitter.
E-mail address	<ul style="list-style-type: none">• Touch to send an e-mail to the e-mail address.• Touch and hold till a context menu appears.<ul style="list-style-type: none">– Touch Send email to send an e-mail to the e-mail address.– Touch Copy to copy the e-mail address to the clipboard. You can paste the e-mail address later to a new contact or while composing a new e-mail.

To check the history of visited web pages

- 1 On the browser screen, touch , or touch the Menu button  → **Bookmarks**.
- 2 Touch the **History** tab.
- 3 Touch the day when your desired web page was last visited.
- 4 Touch a web address to open the web page.





NOTE: To check your most visited web pages, touch the **Most visited** tab.

To allow download of web applications

 **CAUTION:** Applications downloaded from the web can be from unknown sources. To protect your device and personal data, download applications only from trusted sources such as Android Market.

To download web applications, enable your device's downloading feature.

- 1 Touch the Home button  → Menu button  → **Settings** → **Applications**.
- 2 Touch **Unknown sources** to select the check box.
- 3 When the **Attention** dialog box opens, touch **OK**.

To install an application

- 1 On the browser screen, touch the application you want to download.
- 2 The application details screen opens. Read details about the application, such as its cost, overall rating, comments by users, the developer contact info, and more.
- 3 To install the application, select either **Install** if the item is free or **Buy** if it requires purchase.



To check downloads

On the browser screen, touch the Menu button  → **More** → **Downloads**.

Manage Bookmarks



You can store as many bookmarks as you want on your device.

To bookmark a web page



- 1 On the browser screen, go to the web page you want to bookmark.
- 2 Touch  or touch the Menu button  → **Bookmarks**. The Bookmarks window opens.
- 3 On the **Bookmarks** tab, touch the **Add** thumbnail .

- 4 Type the bookmark name or edit the web address as needed.
- 5 Touch **OK** to save the web page as a bookmark.

To open a bookmark

- 1 On the browser screen, touch  or touch the Menu button  → **Bookmarks**. The **Bookmarks** window opens.
- 2 On the **Bookmarks** window, you can either:
 - Touch the bookmark you want to open in the same browser window.
 - Touch and hold the bookmark you want to open, then on the context menu touch **Open** to open the bookmark in the same browser window, or touch **Open in new window** to open the bookmark in a new window.

To manage your bookmarks

- 1 On the browser window, touch  or touch the Menu button  → **Bookmarks**.
- 2 On the **Bookmarks** window, touch and hold a desired bookmark to open the context menu that provides the following options:

Open	Open the bookmarked website in the same browser window.
Open in new window	Open the bookmarked website in a new window.
Edit bookmark	Touch to open the Edit bookmark window. Enter the bookmark's name and address and touch OK .
Add shortcut to Home	Touch to create the bookmark's shortcut on the current Home screen. You can touch the shortcut on the Home screen to start the browser and go directly to the bookmarked page.

Share link	<p>Touch to share the bookmark's address through Bluetooth, e-mail, Facebook, Gmail, text messaging, or Twitter.</p> <ul style="list-style-type: none"> • Bluetooth: Turn on Bluetooth. If your device is not listed under Bluetooth devices, touch Scan for devices. Touch the device you want to share the link with. • Gmail, Email: Touch to open the composing window with the bookmark's address automatically pasted on the text field. Send the bookmark's address to others with an e-mail. • Messaging: Touch to open the message composer with the bookmark's address automatically pasted on the text field. Send the bookmark's address to others with a text message. • Facebook, Twitter: Touch to open the message composing window with the bookmark address pasted. Post the bookmark onto Facebook or Twitter where your online friends can see it.
Copy link URL	Copy the web address of the bookmarked website to the clipboard.
Delete bookmark	Touch to delete the selected bookmark.
Set as homepage	Set the bookmarked website as your browser homepage.



To configure browser settings

On the browser screen, touch the Menu button  → **More** → **Settings** to adjust the browser settings.

E-mail

You can create POP3, IMAP, and exchange e-mail accounts from web-based e-mail services on your device.

To open the e-mail application

Touch the Email button , or touch the Launcher button  →

Email 

To set up an e-mail account

- 1 On the **Set up email** screen, type the e-mail address and password of the e-mail account you want to add and then touch **Next**.

 **NOTE:** If the e-mail account you want to set up is not in the device's e-mail database, you will be asked to manually enter the e-mail account settings, including the e-mail server, protocol, and so on after touching **Next**.

 **NOTE:** Touch **Manual setup** rather than **Next** to directly enter incoming and outgoing settings for the account being set up.

- 2 Enter the name for the account and the name you want displayed in outgoing e-mails and then touch Done.

After creating an e-mail account, touch the Menu button  → **Add account** if you need to create another e-mail account.

To view your e-mails



- 1 The **Combined Inbox** contains all e-mails received in all your accounts.
- 2 E-mail not sent and saved as drafts are stored in the **Drafts** folder.
- 3 Select an account to view e-mails received in the inbox of the account.
- 4 The number of new e-mails received in this account.
- 5 The check symbol indicates that this account is the default account for sending e-mail.
- 6 Touch to view e-mails in the other folders of this account.

To select an account as default for sending e-mail

- 1 Touch an account → Menu button (☰) → **Account settings**, or touch and hold the account, then touch **Account settings** from the context menu.
- 2 Touch **Default account** to select the check box.



To compose and send e-mail



- 1 Touch the Email button , or touch the Launcher button



- 2 Select an email account to use if you have set up more than one account on your device.

 **NOTE:** If you do not select an account, the account marked as default by a check symbol will be the one used for sending e-mail.

- 3 In an e-mail account inbox, touch the Menu button  → **Compose**.
- 4 Type the recipient's e-mail address in the **To** field. As you type information, matching contacts appear on the screen. Touch the recipient to automatically add the e-mail address, or continue typing the e-mail address manually. If you are sending the e-mail to multiple recipients, separate their e-mail addresses with a comma. You can add as many recipients as you need.
- 5 Type the subject.
- 6 Compose your message.
- 7 Touch the Menu button  → **Send**.

 **NOTE:** If you want to save the message as a draft and modify it later, touch  or touch **Save as draft**.



To delete an e-mail

- 1 On the e-mail account inbox, touch and hold the e-mail you want to delete.
- 2 On the context menu, touch **Delete**.

To delete or edit an e-mail account on your device

- 1 Touch the Email button , or touch the Launcher button



- 2 Touch the Menu button  → **Accounts**.
 - To delete an e-mail account, touch and hold the account you want to remove under the **Accounts** bar and then touch **Remove account** on the context menu. When asked to confirm deletion, touch **OK**.
 - To edit an e-mail account, touch an account → Menu button  → **Account settings**, or touch and hold the account and then touch **Account settings** on the context menu.

Web Applications

 **NOTE:** To use the following applications, you require an active Wi-Fi or mobile data network connection (GPRS, EDGE, 3G, 4G, or HSPA). For more information about configuring your device for Internet connectivity, see "Connecting to the Internet" on page 54.

 **NOTE:** Not all applications are available in all versions of this product.

Facebook

Touch the Launcher button  → **Facebook** .

Facebook is a social networking website where you can post your personal profile and pictures, find and contact your friends, classmates or work associates, and exchange messages with them.

To log in to Facebook



- 1 Type your e-mail address and password with which you registered your Facebook account.
- 2 Touch the **Login** button

If you do not have a Facebook account, touch the **Sign up** button and follow the instructions on the screen to create an account.

To use Facebook on your device

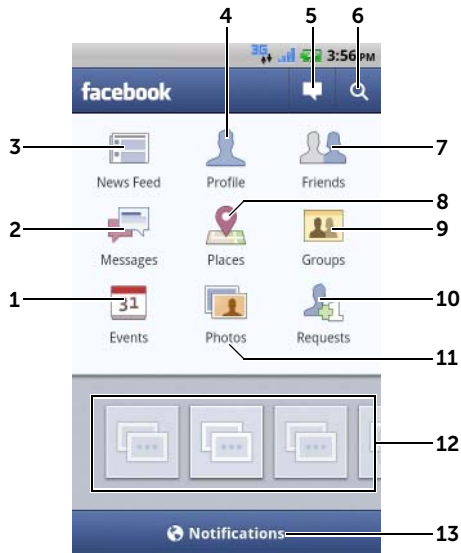
Once logged in, you can touch the Back button  to go to your Facebook main page.



- 1 Touch **Events** to view the events associated with your friends, such as their birthdays.
- 2 Touch **Messages** to view messages sent between you and your friends. Touch the desired message to read it.
 - To delete a message, touch the check box next to the message and then touch the **Delete** button.
 - To reply to the message, type your reply into the text box at the bottom and then touch the **Send** button.
 - To compose a new message, touch the  button, or touch the Menu button  → **Compose**.

-
- 3** Touch **News Feed** to view the messages and pictures you and your friends have posted. From here you can also:
- Type the message you want your friends to know into the **What's on your mind?** text box and then touch the **Share** button to post the message on the Wall of your Facebook Profile page.
 - Touch  to capture a picture and then touch the **Upload** button to post it to your Facebook account for your friends to see.
-
- 4** Touch **Profile** to view your Facebook Profile page.
- Touch the **Wall** tab to view your Facebook wall, where you can see the messages and pictures you and your friends have posted.
 - Touch the **Info** tab to view your account details.
 - Touch the **Photos** tab to view the pictures you have posted.
-
- 5** Touch to compose and post your messages or pictures.
-
- 6** Touch to search for your friends on Facebook.
-
- 7** Touch **Friends**, type the name of a friend you are looking for on Facebook, and touch the name of the friend you found to:
- View the friend's wall, info, and pictures on their profile page.
 - Type a message into the **Write something...** text box on your friend's wall screen. Touch **Share** to post your message on their wall.
-
- 8** Touch **Places** to share your location by "checking in" to a place and letting friends know where you are.
- NOTE:** This feature is only available currently in the U.S.
-
- 9** Touch **Groups** to view the groups you created and share posts with small groups of friends.
-
- 10** Touch **Requests** to view invitations or requests from your friends.
-
- 11** Touch **Photos** to view the pictures you posted.
-
- 12** Touch the reel to view your friends' pictures and videos easily.
-
- 13** Touch or drag **Notifications** to view notifications of your friends' wall postings.
-

The Facebook widget

From the Facebook widget you created on the Home screen, you can view your friends' wall postings.

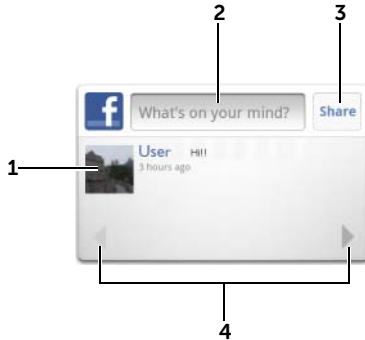

-
- 1 Touch to view a Facebook friend's wall postings.

 - 2 To respond to this friend's postings, touch the text box then type the message you want to post on this friend's wall.

 - 3 Touch **Share** to post your message on this friend's wall.

 - 4 Touch the arrow buttons to scroll and view other friends' postings.



NOTE: For more information on using Facebook, visit [facebook.com/help](https://www.facebook.com/help).

Twitter

Touch the Launcher button  → **Twitter** .

Twitter is a social networking service application that allows you to view short messages called Tweets posted by Twitter users. You can also post your own Tweets for others to read.

To sign in to Twitter

You must have a Twitter account to use Twitter. To set up a Twitter account, touch **Sign up now** and follow the instructions on the screen.

- 1 To sign in to Twitter, type your user name or e-mail address and your password, and then touch **Sign in**.
- 2 Choose whether to sync the people you follow in your Twitter account to your Contacts list, then touch the **Done** button.



NOTE: See "To use the Twitter widget" on page 23 as an alternative way of using Twitter.

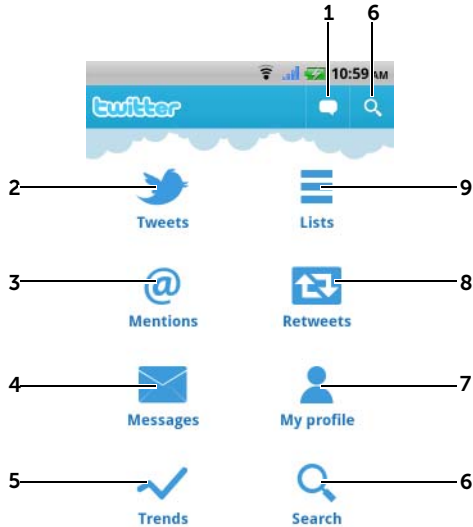

To use Twitter on your device











-
- 1 Touch to compose and post your tweet. See "To create a tweet" on page 75.

 - 2 Touch to read the tweets from authors you choose to follow.
 - Touch an author's picture to view the profile of the author and the tweets from the author.
 - Touch  on a tweet and choose to reply to the author, forward (Retweet) the tweet to your followers on Twitter, add the author to your favorites list, or share the tweet through Facebook, e-mail, Messaging, or Twitter.

 - 3 Tweets that contain "@username" in the body of the tweet are collected in here as "Mentions".

 - 4 Touch to send private tweets, called direct messages, to people you follow. From the Direct messages screen, touch  to compose and send your message. Touch  and choose the person you want to send your message.
-

-
- 5** View the most popular trending topics at the moment.
- Touch the **Current**, **Daily**, and **Weekly** tabs to view the lists of current, daily, and weekly trending topics.
 - Touch a trending topic to view the tweets related to that topic.
-
- 6**
- Touch to search for tweets about a desired topic, or tweets sent by authors around your location.
 - To search for tweets about a topic, type the topic or keyword into the **Search Tweets** text box and then touch .
 - To search for tweets around your location, touch or drag  to turn Location on and then touch  to display available tweets around.
 - Touch to find people who use Twitter.
 - Touch . From the pop-up menu, touch . Type a name in the **Search people** text box, and then touch .
-
- 7** Touch to view your profile and the tweets you posted. To post your profile picture onto Twitter, touch the Menu button  → **Change profile photo**, and then select a desired picture from Gallery.
-
- 8** Touch to read the tweets forwarded by you or by the people you follow.
-
- 9** Organize users you follow into listed groups. To create a list:
- 1** Touch  or the Menu button  → **Create list**.
 - 2** Give the list a name and description.
 - 3** Choose to make the list public (everyone can see it) or private (only you can see it).
 - 4** Touch the **Create list** button to create the list.
-

To create a tweet

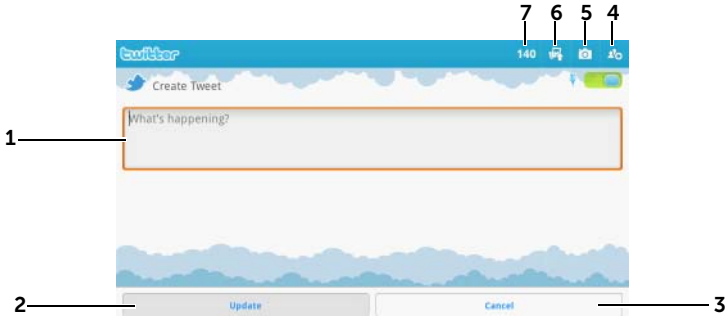

- 1 Type your tweet message here.
- 2 Touch the **Update** button to post your tweet.
- 3 Touch the **Cancel** button to quit composing your tweet.
- 4 Touch to view the people you follow, then select who you want to talk to in your tweet. Their names will appear in your tweet as “@name”.
- 5 Touch to launch the camera and capture a picture to post along with your tweet.
- 6 Touch to open Gallery and select a picture to post along with your tweet.
- 7 Shows the number of remaining characters allowed in your tweet.



NOTE: For more information on using Twitter, visit [Twitter.com/Help](https://twitter.com/help).

Gmail

Gmail is a web-based e-mail service provided by Google.

To open Gmail



Touch the Launcher button  → **Gmail** .

To set up your Google account

You need to sign in to a Google account to use Google applications and services such as Gmail, Google Talk, and Android Market. Signing in to your Google account also synchronizes all e-mails and contacts on your Google account with your device.

 **NOTE:** You will not be required to sign in with your Google account if you have already signed in when previously using an application that requires signing in to your Google account.

- 1 On the **Add a Google account** screen, touch the **Next** button to proceed.
- 2 Touch the **Sign in** button. Enter your Google user name and password, and then touch the **Sign in** button.

 **NOTE:** If you need to use another Google account with a different user name and password on your device, touch the Menu button  → **Accounts** → **Add account** → **Next** → **Sign in**. Enter your Google user name and password and then touch the **Sign in** button.

 **NOTE:** Signing in to your Google Account requires an Internet connection. Ensure that your device has an active Wi-Fi or mobile data connection (GPRS, EDGE, 3G, 4G, or HSPA) before you sign in. For more information on setting up a data connection, see "Connecting to the Internet" on page 54.

 **NOTE:** Touch the **Create** button if you do not have a Google Account.

Your Gmail inbox opens as the default Gmail view. All your received e-mails are delivered to your inbox.



- 1 Folder (or Label) and number of unread e-mails.
- 2 Touch the check box to select the e-mail thread. To use this feature, touch the Menu button  → **More** → **Settings**, then enable **Batch operations**.
- 3 Touch **Archive** to store the selected e-mail thread in the **All Mail** folder.
- 4 Touch **Delete** to delete the selected e-mail thread.
- 5 Touch **Labels** to label the selected e-mail thread.
- 6 Starred e-mail. Touch the star to add or remove the star.
- 7 The number of e-mails grouped under the same subject.

To refresh Gmail

Touch the Menu button  → **Refresh** to send or receive e-mails and to synchronize your e-mails with your Gmail account on the Internet.

To view e-mails in different folders or with labels

To view e-mails stored in the folders other than the inbox, such as in the **Sent** or **All Mail** folders, or to view labeled or starred e-mails:

- 1 Touch the Menu button  → **Go to labels**.
- 2 Touch the folder that stores the e-mails you want to view, or touch the label with which the e-mails are marked.

To read e-mails

- When you receive a new e-mail, the e-mail icon  appears on the status bar to alert you of a new e-mail. Drag down the status bar to open the **Notifications** panel and touch the new e-mail to view it.
- While in the inbox or in any other folder, scroll the e-mail threads on the screen, and then touch an e-mail thread to view the e-mails inside.

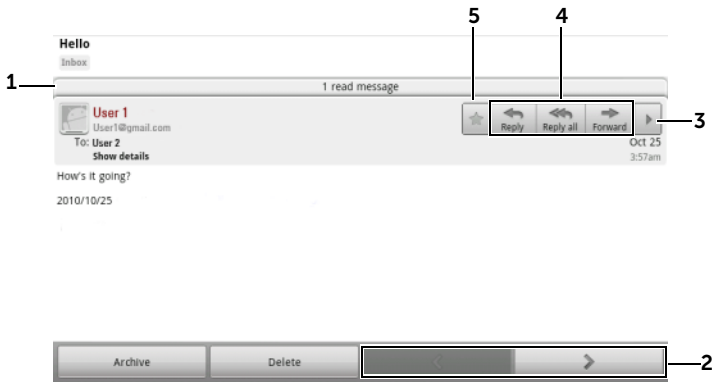



-
- 1 Touch to view previous e-mails with the same subject.





 - 2 Touch to read the next or previous e-mail thread.

 - 3 Touch to open or close the **Reply all** and **Forward** buttons.

 - 4 Touch **Reply** to reply to the contact.
Touch **Reply all** to reply to all contacts in the mail loop.
Touch **Forward** to forward the e-mail to another contact.

 - 5 Touch  to star an e-mail. To check the starred e-mails, in the **Inbox**, touch the Menu button  → **Go to labels** → **Starred**.



To create and send an e-mail

- 1 Touch the Menu button  → **Compose**.
 - 2 Type the contact's e-mail address in the **To** field. To send e-mail to multiple contacts, separate their e-mail addresses with a comma. To send a carbon copy (Cc) or a blind carbon copy (Bcc), touch the Menu button  → **Add Cc/Bcc**.
 - 3 Type the e-mail subject.
 - 4 Compose your e-mail. To attach a picture, touch the Menu button  → **Attach**. Select the picture you want to attach from the Gallery application.
-  **NOTE:** Touch  to remove an attachment.
- 5 Touch **Send** to send the e-mail.

Google Talk

Google Talk is an instant messaging program provided by Google.

To activate Google Talk

- 1 Touch the Launcher button  → **Talk** .
- 2 Sign in to Google Talk with your Google account. If you do not have a Google account, follow the instructions on the screen to create an account (see "To set up your Google account" on page 76).
- 3 The Google Talk window opens with your friends list.

To sign in automatically

You can sign in to your Google Talk account automatically whenever you turn on the device.

- 1 In the friends list, touch the Menu button  → **Settings**.
- 2 Select **Automatically sign in**.

To add a new friend to your friends list



NOTE: You can only add users who have a Google Account.

- 1 In the friends list, touch the Menu button  → **Add friend**.
- 2 Enter the Google Talk instant messaging ID or Gmail address of the friend you want to add to your friends list.



NOTE: When you type the instant messaging ID of a friend who is already a contact saved in Contacts with the same ID, this matching contact will display on the screen before you finish typing. You can touch the contact whose ID is then entered automatically.

- 3 Touch **Send invitation**.

To view and accept an invitation

- 1 In the friends list, touch the Menu button  → **More** → **Invites**. All chat invitations you have sent or received but have not been answered are listed on the pending invitations screen.
- 2 Touch a pending invitation.
- 3 Touch **Accept** or **Cancel**.

When a friend accepts your chat invitation, the pending invitation disappears from the list.

To change your online status and message

- 1 Touch the online status icon  next to your name.
- 2 Select the status you want from the Set Status menu.
- 3 To enter your status message, touch the text box and enter your message.
- 4 To change your ID photo, touch the photo icon to open Gallery, then select the photo to use.
- 5 Touch **Done**.

To start a conversation

- 1 Touch to select a friend in the friends list.
- 2 Type your message in the text box.

- 3 Touch the **Send** button to send the message.

To add a friend to an active conversation

- 1 On the chat screen, touch the Menu button  → **Add to chat**.
- 2 Select the friend you want to invite to the current conversation.

To disable the chat log

On the chat screen, touch the Menu button  → **Chat off record**. The subsequent chat conversations will not be recorded. To resume the chat log, touch **Chat on record**.

To switch between active conversations

- 1 While on a chat screen or in the friends list, touch the Menu button  → **Switch chats**.
- 2 In the panel that opens, touch the name of the friend you want to chat with.

To close a conversation

- In your friends list, touch and hold the name of a friend with an active chat. Touch **End chat** on the menu that pops up.
- On a chat screen, touch the Menu button  → **End chat**.

To display all friends in your friends list

Only the friends that you chat with most frequently are listed as the most popular ones. If you want to display all your friends, touch the Menu button  → **All friends**.

To display a friend in the most popular list

- 1 In the friends list, touch and hold the friend's name to open the options menu.
- 2 Touch **Show friend**.

To always show a friend in most popular list

You can let a friend always appear in your most popular friends list.

- 1 In the friends list, touch and hold the friend's name to open the options menu.
- 2 Touch **Always show friend**.



NOTE: To remove a friend from the most popular list, in the friends list, touch and hold the friend you want to remove from the list, and then touch **Auto show friend** in the options menu.



NOTE: To keep a friend from appearing in the most popular list, touch and hold the friend's name, and then touch **Hide friend** in the menu.

To block a friend from sending you messages

- 1 In the friends list, find the friend to block.
- 2 Touch and hold the friend's name, and then touch **Block friend**.

Your friend is removed from your friends list and is added to the blocked friends list.



NOTE: To unblock a friend, in the friends list, touch the Menu button  → **More** → **Blocked**. In the blocked friends list, touch the name of the friend to unblock, then touch **OK**.

To permanently remove a friend

- 1 In the friends list, find the friend to remove.
- 2 Touch and hold the friend's name, and then touch **Remove friend**.

To find out what device your friend uses to chat on Google talk

- 1 In the friends list, ensure that the Menu button  → **Settings** → **Mobile indicator** is selected.
- 2 In the friends list, check the image that appears to the right of your friend's name. For example, if your friend is using an Android phone, the Android image will appear. If no image is displayed, it indicates that your friend has signed in to Google using a computer.

To sign out from Google Talk

In the friends list, touch the Menu button  → **Sign out**.

Maps



Google Maps helps you find your current location, view real-time traffic situations, and get directions to your destination. You can also use the search tool to locate addresses or places of interest on a map or in a street view.



NOTE: The Google Maps application does not completely cover every location.

To enable location source

To search for desired places or find your current location using Google Maps, you need to enable My location sources:

- 1 Touch Home button  → Menu button  → **Settings** → **Location & security**.
- 2 Select **Use wireless networks**, **Use GPS satellites**, or both.



NOTE: Selecting **Use GPS satellites** allows you to pinpoint locations down to the street-level. However, this mode requires a clear view of the sky and consumes battery power.

To open Google Maps

Touch the Launcher button  → **Maps** .



To see your location on a map

On the Maps screen, touch . Your location is marked on the map with a blinking blue dot.





NOTE: Enabling GPS satellites allows you to pinpoint your current location down to the street-level. However, this mode requires a clear view of the sky and consumes more battery power.

To find a location on the map

- 1 On the Maps screen, touch the Menu button  → **Search**.
- 2 To search by typing:
 - a Type the place you want to find in the search box. You can enter an address, a city or country, or a type of business or organization such "restaurant" or "school".
 - b Touch the search key  on the keyboard or the search icon  on the search box.

To search by voice:

- a Touch .
- b Say your destination.

 **NOTE:** As you enter information, previous searches or matching locations appear below the search box. You can touch a place name or address to show the location on the map.

- 3 The search results are marked on the map by lettered balloons.



- 1 Touch the place name to view the address, details, and reviews for the place if the information is available (For more information, see "To view the details of a place" on page 85).
- 2 Touch to show the list of search results.
- 3 Touch to zoom in or out on the map.
- 4 The search result is marked by a lettered marker. Touch the marker to display the name of the place.

To view the details of a place

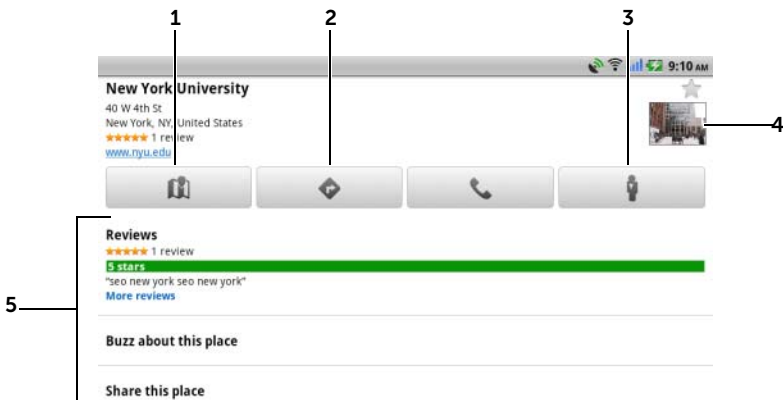



- 1 Touch to display the map view.
- 2 Touch to obtain directions. (For more information, see "To get directions" on page 88).
- 3 Touch to switch to street view for the location. (For more information, see "To view a map in street view" on page 87).
- 4 Touch the photo thumbnail to open the browser and find more information about the location on Google.
- 5
 - Touch to view the address, details, and reviews for the place if the information is available.
 - Select the action you can do with the location. You can select **Buzz about this place** to post your opinions about the place, or select **Share this place** to share the address and contact information about the place using e-mail, Twitter, Facebook, Bluetooth, and more. Scroll down the list to find more actions you can do.

To move around a map

- 1 Flick or drag the map in any direction on the screen to view desired areas.
- 2 If you spot a place of interest while navigating the map, touch and hold the place to display the address (a picture thumbnail is also displayed if the street view for the location is available).



To zoom in or out on a map

- Touch  to zoom out and touch  to zoom in.
- Move two fingers close together on the screen to zoom out; move two fingers further apart to zoom in.

To change map layers

Google Maps opens with the default map layer. You can apply different types of layers to view additional information or images on the map.

- 1 Touch .
- 2 From the **Layers** menu, touch the desired layer to display it on the map.

Map layer

The map layer displays streets, highways, buildings, main establishments, mass transit stations, parks, rivers, lakes, mountains, boundaries, and so on.

Traffic layer

The traffic layer displays colored lines along the roads where real-time traffic data can be collected. Green lines indicate good traffic speeds, yellow lines indicate slower speeds, and brown lines indicate congested traffic.



indicates where construction work is taking place;  indicates where the road is blocked.

Satellite layer

The satellite layer displays the map in non-real-time satellite view.

Terrain layer

The terrain layer combines street maps with visual information about terrains.

Transit Lines layer

The transit lines layer displays mass-transit routes around the area.





NOTE: Touch  → **More Layers** to find more layers that you can apply to the map. For information about the other layers, visit maps.google.com.





NOTE: To remove all of the layers other than the map layer, touch  → **Clear Map**.

To view a map in street view

You can switch to street view for the location that you found on the map. The street view is composed of imagery captured from the streets.

- 1 Locate a place of interest on the map. For more information, see "To find a location on the map" on page 84 and "To move around a map" on page 86.
- 2 On the map, touch the name or address of the place.
- 3 On the location details screen, touch .
- 4 To view the 360-degree panorama of the area around the place, turn the view on the screen with your finger.
- 5 To move the view along the street, touch the arrows displayed on the screen, or touch the Menu button  → **Step forward** or **Step backward**.

 **NOTE:** While viewing a street view of a location, touch the Menu button  → **Compass mode** to enable the compass mode, which allows you to view the area around the selected location by tilting or turning your device, rather than by moving the view on the screen with your finger.

To get directions

Use Google Maps to obtain directions to your destination.

1 When viewing a map:

touch the Menu button  → **Directions**.

Or

When a place is found:

a Touch the place's name or address displayed on the map.

b On the location details screen, touch .

2 Enter the starting point in the first text box and your destination in the second text box.

 **NOTE:** By default, your current location is the starting point, and the place you found on the map is your destination.

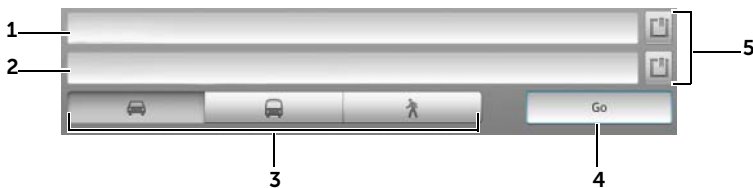

1 Starting point

2 Destination

3 Choose how you want to get to your destination: driving, public transportation, or walking.

4 Touch to render directions.

5 Touch to set your current location, a contact address, or a place on the map as the starting point or destination.

3 Touch **Go**. The directions to your destination are listed.

- 4 Touch **Show on map**, or touch a direction instruction on the list to show the directions or routes on the map.



NOTE: To obtain driving directions using the Google GPS navigation services, touch **Navigate**. For more information, see "Navigation" on page 94.

To clear a map

Touch the Menu button  → **Clear Map**. All the search results, directions and traffic indicators are deleted from the map.

Using Google Latitude



NOTE: To use Google Latitude, you will be required to sign in to a Google account.

The Google Latitude location service allows you to share locations with your friends and family who have signed in to the service with their Google accounts. You can also send instant messages and e-mails, and get directions to your friends' locations.

To let your friends view your location and accept their invitations, you need to enable **Latitude**.

- 1 While viewing a map in any mode, touch the Menu button  → **Join Latitude**.
- 2 Sign in to Google Latitude with your Google account. If you do not have a Google account, follow the instructions on the screen to create an account (see "To set up your Google account" on page 76).



NOTE: If you have set up two or more Google accounts on your device, and want to use Latitude with another account, touch the Menu button  → **More** → **Switch Account**.

- 3 Read the privacy policy. If you accept, touch **Agree & Share**.

To launch Latitude

While viewing a map, touch the Menu button  → **Latitude**.

To invite friends to share locations

- 1 On the Latitude screen, touch the Menu button  → **Add friends**.
- 2 Choose the friends you want to share locations with:
 - **Select from Contacts:** Select friends from your contacts. Friends already using Latitude have an icon next to their names.
 - **Add via email address:** Enter an e-mail address.
- 3 Touch **Add friends** and then touch **Yes**.
- 4 Your friends already using Latitude receive an e-mail request and a notification on Latitude requesting them to share locations. If they have not yet joined Latitude, they receive an e-mail that requests them to sign in to Latitude with their Google accounts.

To accept an invitation

When you receive a request to share your location with a friend on Latitude, touch the request and choose how you want to respond:

- **Accept and share back:** You can see your friend's location, and your friend can see yours.
- **Accept, but hide my location:** You can see your friend's location, but they cannot see yours.
- **Don't accept:** Reject the sharing request. No location information is shared.

To show your friends

You can show your friends on the map or in the list view.

- **Map view**

When you open Google Maps, it displays the locations of your friends. Each friend is marked by a photo icon with an arrow that indicates their location. To see a friend's profile and communicate with them, touch the photo, then touch their location callout right above their photo. To see other friends, touch either one of the arrow buttons next to the callout.

- **List view**

To show a list of your friends, touch the Menu button (☰)→ **Latitude**. To see a friend's profile and communicate with them, touch the friend's name from the list.

To connect with your friends

Touch a friend's name in map view or list view to open the friend's profile. In the profile screen, you can send messages to your friend and configure privacy options.

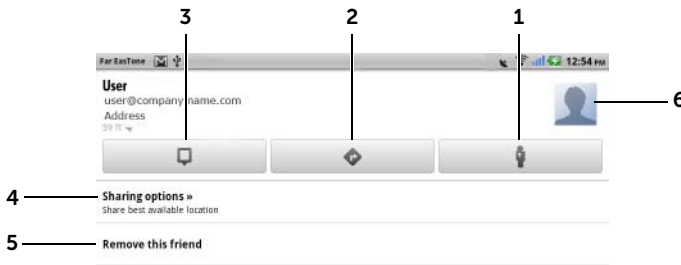

-
- 1 Switch to street view of the friend's location.

 - 2 Get directions to the friend's location.

 - 3 See a friend's location on the map.

 - 4 **Sharing options:**
 - **Share best available location:** Share street-level location with your friend.
 - **Share only city level location:** Share only the city or the approximate area you are in, not the street-level location. Your friend can see your photo icon in the middle of the city you are in.
 - **Hide from this friend:** Stop location sharing with this friend. Your friend cannot see your photo icon on the map.

 - 5 **Remove this friend:** Remove this friend from your list and end all location sharing.

 - 6 Touch the thumbnail to open the pop-up menu. Depending on available settings, you may use Messaging and Gmail services to send a message to your friend.
-

To control what to share and change your public profile

- 1 In Maps, touch the Menu button  → **Latitude**.
- 2 Touch your name on the list of friends to open your public profile window.
- 3 Set the following options to your preferences.

Change your photo	Change the picture that your friends see on the map or in their list of friends. You can take a picture using the Camera application, or select a picture stored in Gallery.
Send location to others	Send the address of your current location using Twitter, Facebook, Bluetooth, text messaging, or e-mail.
Edit privacy settings	Manage how your location is shared with your friends: <ul style="list-style-type: none">• Turn off Latitude: Disable Latitude and end location sharing.• Detect your location: Latitude automatically detects and updates your current location. <p>NOTE: To let Latitude report your location, you must enable My location sources. For more information, see "To enable location source" on page 83.</p> <ul style="list-style-type: none">• Set your location: Select a location from the map, contact addresses or nearby places, or type an address.• Hide your location. All of your friends will not be able to see your location on their maps.

Places

Touch the Launcher button  → **Places** .

Places automatically detects your current location and offers guide to nearby restaurants, coffee shops, bars, hotels, attractions, ATMs, gas stations, and more.

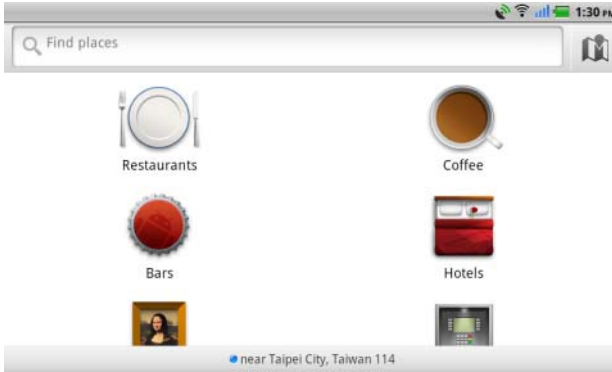

- 1 Touch to select a category.
- 2 From the list of places, touch the desired place to view more details. For more information on using the controls on this screen, see "To view the details of a place" on page 85.

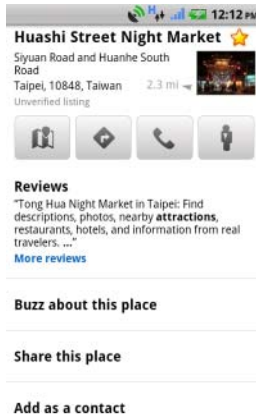

Navigation

 **NOTE:** Google Maps Navigation is only available for use in the United States at this time.

 **WARNING:** It is your sole responsibility to use this application in a safe and responsible manner. You must obey local traffic laws, posted road signs, and safety regulations. Do not operate the device while driving.

Touch the Launcher button  → **Navigation** .

Google Maps Navigation is an Internet-connected GPS satellite navigation system with voice guidance. Navigation provides the following features:

Feature	Description
Searching in plain language	Type the name or address of the place, the business, or the organization you want to find. 

Searching by voice

Name your destination using Google Search by voice (English only).



Feature	Description
Traffic view	Traffic view provides live traffic data and displays up-to-date traffic conditions on the screen. Press the Menu button  → Layers → Traffic to turn on Traffic view.



Searching along route	Search for any kind of business along your route. Press the Menu button  → Layers to access popular types of places.
-----------------------	--



Feature	Description
Satellite View	Satellite view allows you to view your route overlaid on 3D satellite views with Google's high-resolution aerial imagery. Press the Menu button  → Layers → Satellite to turn on Satellite view.
Street View	Street view helps visualize turns with Street View imagery. Navigation automatically switches to Street View as you approach your destination.
Car dock mode	Place your device in a car dock to access Navigation and Voice Search easily.
Navigation shortcut	<ul style="list-style-type: none"> • Speak Destination: Say your destination using Google voice search. • Type Destination: Type your destination. • Contacts: Select a destination from the location of your contacts. • Starred Places: Select a desalination from the list of Starred Places.

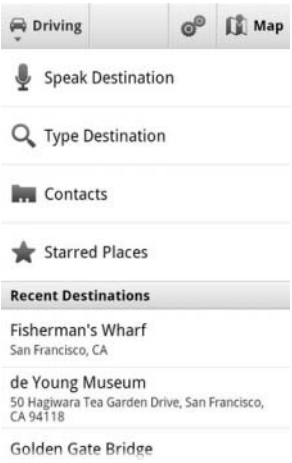

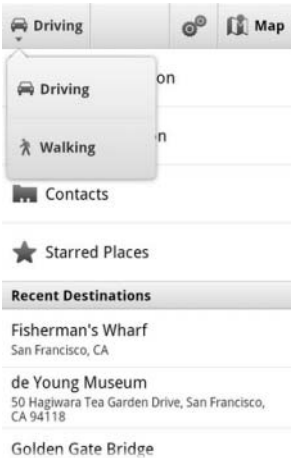
Feature	Description
Walking navigation	<p>Get voice-guided navigation for walking directions. Your device vibrates for turn notifications.</p> 

News and Weather

Touch the Launcher button  → **News and Weather** 



Weather

The Weather service automatically detects your current location and shows the local weather information.



- 1 • Current weather.
 - Touch this area to view temperatures, wind speed, and humidity data within the next 24 hours.
- 2 Weather forecast for the next 6 days.
- 3 Touch the **The Weather Channel** icon to start the browser and visit **The Weather Channel** website to find more weather information.

If your current location is temporarily unavailable, you need to set your location manually as follows.

- 1 Touch the Menu button  → **Settings** → **Weather settings**.
- 2 Clear the **Use my location** check box.
- 3 Touch **Set location**.
- 4 Enter a city or postal code.
- 5 Touch . The weather location will be updated to the location you manually set.

News

Flick pages horizontally to view news topics, such as **Top Stories**, **U.S.**, **Sports**, and **Entertainment**. Touch the news headline you are interested in to view the full content.

To add/remove news topics

You can manage the news topics to be displayed on your device as follows.

- 1 Touch the Menu button  → **Settings** → **News settings**.
- 2 Touch **Select news topics**.
 - Select the check boxes next to the news topics you want to display on the device.
 - Clear the check boxes next to the unwanted news topics.

To configure news and weather refresh settings

- 1 Touch the Menu button  → **Settings** → **Refresh settings**.
- 2 To refresh news and weather automatically, select the **Auto-refresh** check box.
- 3 Touch **Refresh interval** to adjust the refresh interval. Faster refresh intervals increase data usage and consume more battery power.



NOTE: To refresh news and weather manually, touch the Menu button  → **Refresh**.

YouTube





YouTube is an Internet video streaming service that allows you to view videos uploaded by YouTube members.

 **NOTE:** Browsing and watching videos does not require you to sign in to a YouTube account. However, to use full YouTube features, such as commenting on videos, adding videos to your favorites, or uploading videos, you must create and sign in to a YouTube account.

To open YouTube



Touch the Launcher button  → YouTube .

To search for a video by typing



- 1 Touch the icon  on the top right of the YouTube screen, or touch the Menu button  → **Search** to open the search bar.
- 2 Type the video name or keyword into the search box using the on-screen keyboard. The search results that fully or partially match the text being typed appear below the search box. You can:
 - a Scroll the search results and touch the desired result.
 - b Touch  on the keyboard or the search icon  on the search box to search for results that match the entered text, and then touch a desired search result.
- 3 The videos that match the selected result are listed.
- 4 Touch the video to start playing the video.

 **NOTE:** You can touch **All time** (or the current time filter setting) at the top of the search results screen. From the **Time filter** pop-up menu, select a time frame you want to filter the search results. The videos that match the selected time frame will be listed.

To search for a video by voice command

- 1 Touch the  icon on the top right corner of the YouTube screen, or touch the Menu button  → **Search** to open the search bar.
- 2 Touch .
- 3 Say the video name or a keyword.
- 4 The videos that match the words you said are listed.
- 5 Touch the video to start playing the video.

To watch videos in the Landscape format



- 1 Place the device in the Landscape format.
- 2 Select a video on the YouTube screen. Touch the video to start the playback in full screen.
- 3 To control video playback, touch anywhere on the screen to bring up the controls.
- 4 Touch the screen again to pause the playback. When paused, the  icon appears.
- 5 Touch the screen again to resume the playback.
- 6 To end playback, touch the Back button  or the Home button .



NOTE: In full screen, you can touch **HQ** to toggle High Quality (HQ) mode or touch **CC** to enable subtitles (if available).

To watch videos in the Portrait format

- 1 Place the device in the Portrait format.
- 2 Select a video on the YouTube screen. Touch the video to start the playback in the top half of the screen.
- 3 Touch the screen to pause the playback. When paused, the  icon appears.
- 4 Touch the screen again to resume the playback.

While the video is playing, you can touch  if you like the video, or touch  if you do not like the video. You can also touch **More** to add the video to your favorites, save it to a playlist, share it, copy its URL, or flag it.



In the bottom half of the screen, you can flick the **Info**, **Related videos** and **Comments** tabs to view the information about this video, browse related videos, and read comments.

 **NOTE:** Some of the features above may require signing in to your YouTube account.

To use YouTube menu options

In YouTube, you can touch the Menu button  to access the following menu options, some of which may require signing in to your YouTube account.

Home	Return to the YouTube main screen.
Browse	Browse videos from a list of categories.
Search	Search for videos.
My Channel	Access your video uploads, favorite videos, video playlists, and video subscriptions. You can also sign out from this page.
Upload	Upload videos from your device.
Settings	Customize your YouTube preferences and settings.

 **NOTE:** For more information on using YouTube, touch the Menu button  → **Settings** → **Help**.

Android Market

You can use Android Market to download and install applications and games on your device.



NOTE: Applications downloaded from Android Market may not support automatic screen rotation to portrait or landscape.

To open Android Market

- 1 Touch the Launcher button  → **Market** .
- 2 Sign in to Android Market with your Google account. If you do not have a Google account, follow the instructions on the screen to create an account (see "To set up your Google account" on page 76).
- 3 Touch the **Accept** button after you read and agree with the **Android Market Terms of Service**.

4 The Android Market screen opens.



-
- 1
- Touch **Apps** to view the application categories. All applications available for download are sorted by these categories.
 - Touch **Games** to view the game categories. All games available for download are sorted by these categories.
-
- 2
- The Market screen displays popular application categories here for direct access.
-
- 3
- The Market screen opens with featured applications for direct access.
-
- 4
- Shows user rating about the item and whether it is free or requires a purchase.
-
- 5
- Touch **Downloads** to view your downloads.
-
- 6
- Touch to search Android Market for applications or games.
-

When a category is selected, for example, touch the **Games** tab→
Brain & Puzzle:



- 1 Touch **Top paid** to view the paid games downloaded most often.
- 2 Touch **Top free** to view the free games downloaded most often.
- 3 Touch **Just in** to view new games available for download.
- 4 Touch the game to download and install on your device.

To download and install an application or game

- 1 Scroll and browse listed applications or games to locate the desired application or games.
- 2 Touch the application or game you want to download and install.
- 3 On the application details screen, you can read the introduction to the application or game, user ratings and comments, and developer information.





NOTE: Touch the Menu button (☰) and select **Security** to view the functions or data that the application or game can access on your device.

- 4 On the application details screen, touch **Install** to start the download and installation. The application's downloading screen will show the download progress.



NOTE: If the application requires access to any of your data or functions on your device, Market tells you what the application can access. Touch the OK button to start the download and installation.

 **NOTE:** During installation, the  icon appears in the notification area of the status bar. Touch the notification area of the status bar to open the Notifications panel and check the status of the download.

 **NOTE:** To stop downloading an application, touch Cancel download on the application's downloading screen.

- 5 After the application is downloaded and installed on your device, the  icon appears in the notification area of the status bar.

To open an application or game

From the Market screen:

- 1 Touch the **Downloads** tab on the Market screen, or touch the Menu button  → **Downloads**.
- 2 Touch the installed application in the list.
- 3 Touch **Open**. The selected application starts running.

From the main application menu:

- 1 Touch the Launcher button .
- 2 Touch the application's icon.

From the status bar:

- 1 Drag down the status bar to view the **Notifications** panel where the  icon appears to indicate a recently downloaded application.
- 2 Touch the name of the application you want to open.



To uninstall an application or game

- 1 On the downloads screen, touch the application you want to uninstall.
- 2 Touch **Uninstall**.
- 3 After the uninstall is completed, you can select the reason for removing the application.

Synchronizing Your Google Data

Through a web connection, your device can synchronize your Google data including Gmail, calendar, and contacts with your computer or any other device that you use to access your Google account.



To select the applications to synchronize

- 1 Touch Home button  → Menu button  → **Settings** → **Accounts & sync**.
- 2 Under the **General sync settings** bar, touch to select **Background data** to make all the sync options available.
- 3 Under the **General sync settings** bar, touch to select **Auto-sync** to allow the device to automatically synchronize the selected data.
- 4 Under the **Manage accounts** bar, touch your account to select the data that you want the device to synchronize automatically, such as **Sync Contacts**, **Sync Gmail**, **Sync Picasa Web Albums**, and **Sync Calendar**.



NOTE: If you want to synchronize individual applications manually, touch to clear the **Auto-sync** check box, then touch a data option to start synchronization of the selected data. To sync all of the data manually, touch the Menu button  → **Sync now**.









NOTE: While data is syncing, the sync icon  appears on the status bar, and the sync icon  appears on the option of the data being synced.

Customizing Your Dell Streak 7 Tablet

You can customize your device, using the options available in the **Settings** menu.

Display Settings

To change the display settings:

- 1 Touch the Home button  → Menu button  → **Settings** → **Display**, or
touch the Launcher button  → **Settings** icon  → **Display**.
- 2 Touch the desired item under **Display settings**.
- 3 To enable a setting, touch the setting option to select the check box ; to disable a setting, touch the setting option to clear the check box .

Brightness

Manually adjust screen brightness.

- 1 Drag the brightness slider horizontally or touch the desired portion on the slider. The length of the highlighted bar on the slider determines the brightness of the screen.
- 2 Touch **OK** to confirm the adjustment.

NOTE: If **Automatic brightness** is enabled, the device will adjust the screen brightness automatically based on the surrounding light conditions.



Auto-rotate screen

If enabled, the screen will switch the orientation to landscape or portrait as you rotate the device.

Animation	Set the device to play an animation for opening and closing windows.
Screen timeout	<ul style="list-style-type: none"> • Set the duration the screen remains on after the last operation. Scroll the options and touch a preferred timeout period; to disable this feature select Never timeout. • The screen automatically turns off and locks itself based on the preset timeout duration. • To turn on and unlock the screen, press the Power button and then flick the  icon up to unlock the screen if it is automatically locked. <p>NOTE: If you select Never timeout, the screen does not turn off, and depletes the battery charge soon.</p> <p>NOTE: You must draw the unlock pattern if you have set up and enabled the screen lock pattern. For more information, see "Protect Your Device Data With a Screen Unlock Pattern" on page 113.</p>

Sound and Ringtone Settings



To change the sound and ringtone settings:

- 1 Touch the Home button  → Menu button  → **Settings** →

Sound, or touch  → **Settings** icon  → **Sound**.

Use the options under **Sound settings**, and then touch a desired option.

- 2 Flick the list to locate and touch a desired option.

- 3 To enable a setting, touch the setting option to select the check box ; to disable a setting, touch the setting option to clear the check box .

General settings

Silent mode	Silence all sounds except media and alarms.
Vibrate	Set the device to vibrate based on the available settings.
Volume	<ul style="list-style-type: none">• Ringtone: Adjust the ringer volume for notifications.• Media: Adjust the volume for music and video playback.• Alarm: Adjust the volume for alarm ringtone. <ol style="list-style-type: none">1 To adjust the volume, drag the sliders horizontally or touch the desired portion of the slider to increase or decrease volume.2 Touch OK to confirm the adjustment.

Notifications settings







Notification ringtone	Select a desired ringtone for notifications.
Notification sound	Select this item to enable notification sound.

Feedback settings

Audible selection	Plays a tone as you touch the screen to select items.
Screen lock sounds	Plays a tone when the screen is locked and unlocked.
Haptic feedback	The device vibrates when you touch the buttons or when specific interactions with the device occur.

Date, Time, and Time Zone



To manually set the date, time, and time zone:

- 1 Touch the Home button  → Menu button  → **Settings** → **Date & time**, or touch  → **Settings** icon  → **Date & time**.
- 2 Flick the list to locate and touch the desired item.
- 3 To enable a setting, touch the setting option to select the check box ; to disable a setting, touch the setting option to clear the check box .

Select time source

Choose to set the device time manually or automatically from your mobile network or from the Internet.



Set date

- 1 Touch or touch and hold  or  to adjust the day, month, and year; you can also touch the day, month, or year to type a date using the on-screen keyboard.
- 2 Touch **Set** to confirm the date.

Set time zone

Select a city or region that represents the time zone for your device. Touch the Menu button  to sort the time zone list alphabetically or by time zone.





Set time

- 1 Touch or touch and hold  or  to adjust the hour and minute; you can also touch the hour or minute to type a time using the on-screen keyboard.
 - 2 Touch the AM/PM button if the 12-hour format is in use.
 - 3 Touch **Set** to confirm the time.
-

Use 24-hour format	Clear this check box to display the time in 12-hour format.
Select date format	Select the format to be used for displaying the date.

Language Settings

To set the language of the display text:

- 1 Touch the Home button  → Menu button  → **Settings** → **Language & keyboard** → **Select language**, or
touch  → **Settings** icon  → **Language & keyboard** → **Select language**.
- 2 Select a language of your choice from the Locale list that appears.

Protecting Your Dell Streak 7 Tablet

Protect Your Device Data With a Screen Unlock Pattern

You can protect your device data against unauthorized access by locking the touch screen with a screen unlock pattern. Once the unlock pattern is enabled and the screen is locked, you need to draw the correct unlock pattern to unlock the screen.





After you fail to draw the correct unlock pattern on the screen for five consecutive times, you will be asked to wait for 30 seconds before you can try again. If you no longer remember your screen unlock pattern, follow these steps to unlock your screen:

- 1 Touch **Forgot pattern**.
- 2 When prompted, sign in to the Google website using your Google account name and password.
- 3 Draw a new screen unlock pattern as described in "To create a screen unlock pattern" on page 113.





NOTE: If you are unable to obtain a new unlock pattern following the above steps, visit support.dell.com.

To create a screen unlock pattern





- 1 Touch the Home button  → Menu button  → **Settings** → **Location & security** → **Set up screen lock** → **Pattern**, or touch the Launcher button  → **Settings** icon  → **Location & security** → **Set up screen lock** → **Pattern**.
- 2 Read the instructions on the screen and then touch **Next**.

- 3 Study the animated example of how to draw a pattern. Then touch **Next** when you are ready to draw your own pattern.









- 4 Drag your finger to draw the unlock pattern by connecting at least four dots in a vertical, horizontal and/or diagonal direction. Take your finger off the screen when a pattern is drawn.
-  **NOTE:** You must touch and drag your finger on the screen to create the pattern.
- 5 The device records the pattern if it is correctly drawn. Touch **Continue**.
 - 6 Draw the pattern again as prompted, and then touch **Confirm**.
-  **NOTE:** To change your unlock screen pattern, you need to draw the old pattern and perform steps 4 to 6 to create a new pattern.

To disable or change the screen unlock pattern

- 1 Touch the Home button  → Menu button  → **Settings** → **Location & security** → **Change screen lock**, or
touch the Launcher button  → **Settings** icon  → **Location & security** → **Change screen lock**.
- 2 Draw the pattern you created.
- 3 Select **None** to disable screen unlock security; select **Pattern** to draw a new unlock pattern.

To change unlock pattern settings

- 1 Touch the Home button  → Menu button  → **Settings** → **Location & security**, or
touch the Launcher button  → **Settings** icon  → **Location & security**.
- 2 To enable a setting, touch the setting option to select the check box ; to disable a setting, touch the setting option to clear the check box .





Use visible pattern

Clear this option if you do not want the lines of the unlock pattern to display on the screen when you draw it.





Use tactile feedback

Clear this option if you do not want the device to give you tactile feedback when drawing the unlock pattern.





Protect Your Device Data With a PIN

- 1 Touch the Home button  → Menu button  → **Settings** → **Location & security** → **Set up screen lock** → **PIN**, or
touch the Launcher button  → **Settings** icon  → **Location & security** → **Set up screen lock** → **PIN**.
- 2 On the **Choose your PIN** page that appears, enter a PIN in the text box. Your PIN must be 4 characters at least.
- 3 Touch **OK** to proceed.
- 4 Enter the PIN again to confirm.
- 5 Touch **OK**.





To disable or change PIN

- 1 Touch the Home button  → Menu button  → **Settings** → **Location & security** → **Change screen lock**, or
touch the Launcher button  → **Settings** icon  → **Location & security** → **Change screen lock**.
- 2 Enter the PIN you have enabled.
- 3 Select **None** to disable the PIN; select **PIN** to change PIN.

Protect Your Device Data With a Password

- 1 Touch the Home button  → Menu button  → **Settings** → **Location & security** → **Set up screen lock** → **Password**, or
touch the Launcher button  → **Settings** icon  → **Location & security** → **Set up screen lock** → **Password**.
- 2 On the **Choose your password** page that appears, enter a password in the text box. A valid password consists of at least 4 characters and contains at least one letter.
- 3 Touch **OK** to proceed.
- 4 Enter the password again to confirm.
- 5 Touch **OK**.

To disable or change the password

- 1 Touch the Home button  → Menu button  → **Settings** → **Location & security** → **Change screen lock**, or
touch the Launcher button  → **Settings** icon  → **Location & security** → **Change screen lock**.
- 2 Enter the password you have enabled.
- 3 Select **None** to disable the PIN; select **Password** to change the password.

Protect Your SIM Card With the SIM Lock Password

You can protect your SIM card against unauthorized use with a personal identification number (PIN). After a PIN is enabled to lock your SIM, you will need to enter the PIN each time you turn on the device in order to unlock your SIM.







NOTE: The SIM card will be permanently locked if you enter the incorrect PIN for three consecutive times. You must then enter the Personal Unblocking Key (PUK) to unlock the SIM card. Contact your service provider to obtain the PUK.

To enable the SIM card PIN

- 1 Touch the Home button  → Menu button  → **Settings** → **Location & security** → **Set up SIM card lock** → **Lock SIM Card**, or touch the Launcher button  → **Settings** icon  → **Location & security** → **Set up SIM card lock** → **Lock SIM Card**.
- 2 Type your SIM card PIN, and then touch **OK**.

To change the SIM card PIN

- 1 Touch the Home button  → Menu button  → **Settings** → **Location & security** → **Set up SIM card lock** → **Change SIM PIN**, or touch the Launcher button  → **Settings** icon  → **Location & security** → **Set up SIM card lock** → **Change SIM PIN**.
- 2 Type the old SIM card PIN, and then touch **OK**.
- 3 Type the new SIM card PIN, and then touch **OK**.
- 4 Type the new SIM card PIN again, and then touch **OK**.

Applications

Camera

Your device has a camera with auto-focus feature that allows you to capture and share high-quality pictures and videos.

To start the camera in picture mode

Touch the Launcher button  → **Camera** .

Camera controls

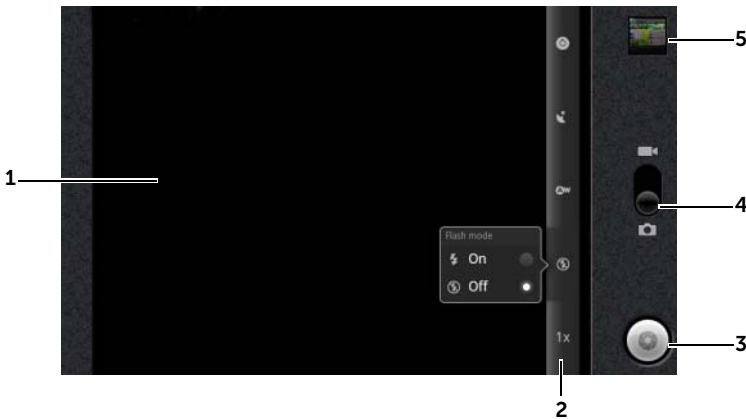

-
- 1** Viewfinder screen.
 - 2** Camera setting indicator. Touch each indicator to open the camera settings, and touch to select the desired setting.
 - 3**
 - On-screen shutter button.
 - To capture a picture:
 - 1** Focus on the object in the viewfinder screen.
 - 2** To start the auto focus mode, touch and hold the on-screen shutter button.
 - 3** Touch the on-screen shutter button and release to capture the picture.
-

-
- 4 Drag this on-screen switch to toggle between the camera mode for capturing pictures, and the camcorder mode for capturing videos.
-
- 5 Touch the thumbnail view of the last taken picture to view and manage the picture using the Gallery application.
-

Additional camera settings

Touch the Menu button .

Front-Facing/Rear-Facing Camera	Use the front-facing or rear-facing camera to capture pictures.
Gallery	Open the Gallery application to view and manage pictures.
Switch to video/camera	Toggle between the camera mode for capturing pictures, and the camcorder mode for capturing videos.

To start the camcorder mode

Touch the Menu button  → **Switch to video**, or touch  to switch to the camcorder screen.

Camcorder controls



-
- 1 Viewfinder screen.
-

-
- 2 Camcorder setting indicator. Touch each indicator to open the camcorder settings.
-
- 3 To start or stop recording, touch this on-screen video recording button.
-
- 4 Drag this on-screen switch to toggle between the camera mode for capturing pictures, and the camcorder mode for shooting videos.
-
- 5 Touch the thumbnail view of the last captured video to play and manage the video using the Gallery application.
-

Copying Files to and From the Device

To exchange pictures, videos, music, and other files between your device and a computer, you can use the internal device storage or the SD card as a USB drive, by connecting the device to a computer with the included USB cable.

 **NOTE:** To copy files to and from your SD card, you need to install the SD card in your device. For more information on how to install a SD card on your device, see "Insert the SD card" on page 11.

To set the SD card or the internal device storage as a USB drive

- 1 Connect the device to the computer by connecting the 30-pin connector into the device and the USB connector into the USB port on the computer.
- 2 The **USB connected** screen appears and the **USB connected** banner flashes on the status bar. The USB notification icon  appears on the status bar's notification area when the device is connected to the computer.

 **NOTE:** If the **USB connected** screen does not appear, drag down the status bar to open the Notifications panel, and then touch **USB connected** to open the **USB connected** screen.

- 3 Touch **Turn on USB storage**, if you want to copy files between your computer and the SD card or the internal device storage.
- 4 Open the **My Computer** window on your computer to locate two removable drives, which represent respectively the SD card installed in your device, and the internal device storage.

- 5 Copy the desired files such as music or pictures from another drive/folder to one of the removable drives, or vice versa.

To turn off USB storage

The device will not recognize the SD card and the internal device storage when they are being used as a USB drive. You will not be able to use the device's applications that involve saving or retrieving files on the SD card and on the internal device storage, such as camera or music playback. You need to turn off USB storage for the device to recognize the SD card and the internal device storage, when the device is connected to a computer.

To turn off the USB storage function:

- 1 Drag down the status bar to open the Notifications panel.
- 2 Touch **Turn off USB storage**.



Bluetooth®

Bluetooth is a short-range wireless communications technology that lets your device connect over a wireless network to other Bluetooth-enabled devices for data exchange.

Bluetooth on your device operates in three different modes:



On	Bluetooth is turned on. Your device is enabled to detect Bluetooth devices within range, but will not be found by them.
Discoverable	Bluetooth is turned on, and other Bluetooth devices can detect your device.
Off	Bluetooth is turned off. Your device cannot send and receive data using Bluetooth.

To turn on Bluetooth and make the device discoverable

- 1 Touch the Home button  → Menu button  → **Settings** → **Wireless & networks**.
- 2 Select the **Bluetooth** check box to turn on Bluetooth. The Bluetooth icon  appears in the status bar.

- 3 Touch **Bluetooth settings**, then select the **Discoverable** check box to make the device recognizable by other nearby Bluetooth devices.

To pair and connect a Bluetooth device

- 1 Touch the Home button  → Menu button  → **Settings** → **Wireless & networks** → **Bluetooth settings**.
- 2 Touch and select the **Bluetooth** check box. Your device starts to scan for Bluetooth devices within range and then displays all detected devices below the **Bluetooth devices** banner.



NOTE: To detect more devices, touch **Scan for devices**.

- 3 To initiate a connection with a device, touch the name of the device.
- 4 You may be prompted to enter a password to authenticate. Enter the same password on both devices, or enter the password provided by the device manufacturer. Ensure that you read the documentation of the pairing device to check if it requires a default password.
- 5 When the pairing is successful, **Paired but not connected** is displayed under the paired device.
- 6 Touch the paired device to start connection. When the paired device is successfully connected to your device, the Bluetooth connected icon  appears in the status bar.



NOTE: To listen to the music using a Bluetooth headset, pair it first with your device.





NOTE: Pairing is a one-time process. Once your device successfully pairs with another device, your device recognizes that device without re-entering your password.

To end a Bluetooth connection



- 1 Touch the Home button  → Menu button  → **Settings** → **Wireless & networks** → **Bluetooth settings**.
- 2 Touch and hold the name of a connected device.

- 3 Touch **Disconnect** on the pop-up menu that appears.

To terminate a pairing partnership

- 1 Touch the Home button  → Menu button  → **Settings** → **Wireless & networks** → **Bluetooth settings**.
- 2 Touch and hold the name of a paired device.
- 3 Touch **Unpair** on the pop-up menu that appears to erase all pairing information with that device. You need to re-enter the password if you want to restore a Bluetooth connection to that device.

To change your device's Bluetooth name

- 1 Ensure that you have turned on Bluetooth on your device ( icon in the status bar indicates that Bluetooth is enabled).
- 2 Touch the Home button  → Menu button  → **Settings** → **Wireless & networks** → **Bluetooth settings** → **Device name**.
- 3 Enter a name to identify the device when you connect using Bluetooth.
- 4 Touch **OK**.

Gallery

To view and manage the pictures and videos stored on your device,

touch the Launcher button  → **Gallery** .

The Gallery application displays not only the pictures and videos stored on your SD card, but also those uploaded to the Picasa web album of your Gmail account which you signed in with on your device.

To share or delete albums



All pictures and videos are grouped in separate albums as overlapping thumbnails, according to their dates, sources, or folders in which they are stored. For example, pictures taken using the device camera are grouped as **Camera**, and downloaded pictures are grouped as **download**.



Overlapping thumbnails as one album.

- 1 Touch and hold an album until the check box  appears.
 - 2 Touch more albums to select them if you want to do the same task for those albums.
- To post the selected album to Picasa or video album to YouTube, or to send the album using Bluetooth, messaging, or e-mail, touch **Share**.
 - To delete the album, touch **Delete**.



To browse picture and video thumbnails

- 1 Touch an album to display the thumbnails of all pictures and videos inside.
- 2 To browse the thumbnails:
 - Touch or drag  to display all the thumbnails in grid view, or group them by date as overlapping thumbnails.
 - When the thumbnails are displayed in grid view, drag  or touch the arrows on it to move thumbnails horizontally, until the desired thumbnail is located.



- 3 To select a thumbnail, touch and hold it until  appears; touch more thumbnails as you need.
- To post a selected picture or video to Facebook, Twitter, Picasa, YouTube, or to send it using Bluetooth, messaging, or email, touch **Share**.
 - To delete a selected picture or video, touch **Delete**.
 - To set a picture as the Home screen wallpaper, touch **More**→ **Set as**→ **Wallpaper**.
 - To set a picture as a contact's picture ID, touch **More**→ **Set as**→ **Contact icon**.

To display a full picture

Touch a desired picture thumbnail to display the picture in full screen.

- Flick the picture to view the next or previous one.
- To bring up the picture viewing controls, touch anywhere on the screen, or touch  twice.
- To zoom the picture in or out, you can:
 - Touch  .
 - Pinch the picture with two fingers, then move the fingers away from each other to enlarge the view of the picture, or bring them closer together to reduce the view of the picture.
 - To zoom in or out on a particular area of the picture, tap that area twice.
 - When a picture view is being enlarged, flick or drag the enlarged picture across the screen until the required area appears.

To play a video

- 1 Touch a video thumbnail to start playback of the video.
- 2 To control playback, use these controls below the viewing screen:
 - Touch the  button to pause and the  button to resume playback.

- Touch or drag the playback progress bar at the bottom to rewind or fast-forward the video.

Music

To open Music

Touch the Launcher button  → **Music** .

The Music library screen opens, which is organized by **Artists**, **Albums**, **Songs**, and **Playlists** tabs. You can touch a tab to display your desired category.

To select a song

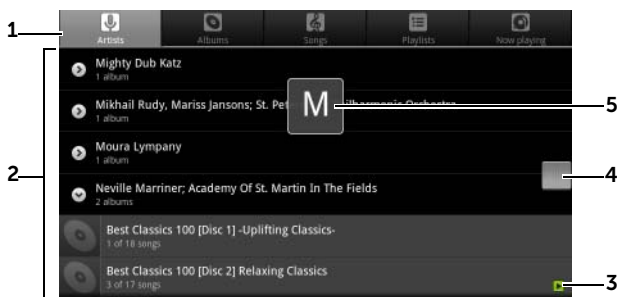

- 1 All the music files available on your device are grouped into these categories: **Artists**, **Albums**, **Songs**, and **Playlists**. Touch a category to view the list within it.



NOTE: If you rotate your device to landscape mode, an additional **Now playing** category appears.

- 2 Flick the list until you find the music you want to play. For instance, to select music by artist:
 - a Flick the list of artists in alphabetical order.
 - b Touch the name of an artist. A list of albums by the artist appears.
 - c Touch an album to find the songs inside.
 - d Touch a song to open the music playback screen and play the music.
- 3  indicates the current album or song being played.

-
- 4 You can flick or drag a long list, and then drag the icon  that appears to quickly scroll the list by alphabet.
-
- 5 The letter icon indicates the alphabet of the list you scroll to.
-

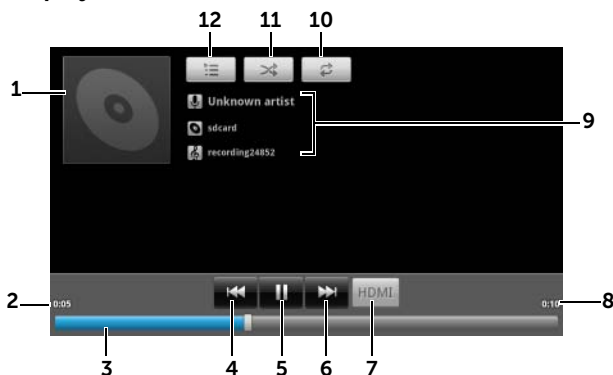
To control music playback



-
- 1 The album's cover image if present.
-
- 2 The passing playback time.
-
- 3
- Touch the playback control bar to jump to any part of the song.
 - Drag and scroll the playback control bar forward to fast-forward the song.
 - Drag and scroll the playback control bar backward to rewind the song.
-
- 4
- If the song is playing for more than five seconds, touch to jump to the beginning of the song.
 - If the song is playing for less than five seconds, touch to play the previous song.
-
- 5 Touch  to pause playback; touch  to resume playback.
-
- 6
- Touch to play the next song.
 - Touch and hold to fast-forward the song.
-
- 7 Touch to turn the HDMI mode on and off when connecting to an HDMI output device.
-
- 8 The duration of the song.
-

-
- 9
 - The name of the artist, album, and the song being played.
 - Touch and hold the artist, album, or song to search for relevant information or videos from the Internet using the Browser or Youtube application, or do the search inside the Music application.
-
- 10 Touch to cycle through the repeat modes.
-
- 11 Touch to turn the shuffle mode on and off.
-
- 12 Go to the Now playing list.
-



NOTE: Press the volume up button or volume down button to adjust the playback volume.



NOTE: On the Music library screen, touch **Shuffle all** to play all songs in your library in random order. The first randomly selected song starts to play.

To create a playlist

- 1 On the **Music** screen, touch the **Artists, Albums, Songs** tabs as needed.
- 2 Flick the screen until you reach the artist, album, or song that you want to add to the playlist.
- 3 Touch and hold the artist, album, or song that you want to add in the playlist. A pop-up menu opens.
- 4 Touch **Add to playlist**.
- 5 In the **Add to playlist** window, touch **New**.



NOTE: If you want to add the artist, album, or song to the current playlist, touch **Current playlist** in the **Add to playlist** options menu.

- 6 Enter the name for your new playlist in the text field and then touch **Save**.

Calendar

Use the calendar to schedule and manage your events, meetings, and appointments.

To open the calendar

Touch the Launcher button  → **Calendar** .

To set up an event

- 1 On any calendar view, touch the Menu button  → **More** → **New event** to open the **Event details** screen.
- 2 Type the event name using the on-screen keyboard.
- 3 If there is a time period for the event, touch and type the **From** and **To** date and time.
If the event is a special occasion such as a birthday or takes a whole day, set the **From** and **To** date, and then select the **All day** check box.
- 4 Type the event location and description.
- 5 If you have set up more than one account on your device, under the **Calendar** option, choose the account calendar to which to add the event.
- 6 To invite your friends to join this event, type their e-mail addresses into the **Guests** text box. The invitation will be e-mailed to them when this event is set up.
- 7 Decide whether it is a recurring event in **Repetition** and choose how often it occurs.
- 8 In **Reminders**, set when the reminder appears before the event.
- 9 Touch **Done** and the event is created.



NOTE: To quickly set up an event in day, week, or month view, touch and hold an empty time slot → **New event**. A new **Event details** screen opens with the selected time slot and date in the **From** and **To** fields.

To view the calendar

You can display the calendar in daily, weekly, monthly, or agenda view.

To change the calendar view, touch the Menu button →

Day/Week/Month/Agenda/Today.

While viewing the calendar you can:

- In day or week views, touch an event to open a quick view window of the event on the lower part of the screen.
- Touch the event or the quick view window to view details about the event.
- Touch and hold an event to open a menu with options for viewing, editing, or deleting the event, or creating a new event.

To view and synchronize multiple calendars

If you have set up more than one account on your device, you can view multiple calendars from the accounts on your device. You can configure which calendars to synchronize to the device, and which of those to show or hide on the device in **Calendar**.

To set whether calendars are synchronized to the device or visible, follow the steps below.

- 1 In Calendar, touch the Menu button → **More**→ **Calendars**. The **Calendars** screen displays all the calendars you have added or subscribed to for each account on your device, organized by account. Touch the name of an account to show or hide its calendars on your device. The icon to the right of each calendar indicates whether the events on that calendar are synchronized to the device and whether they are visible in **Calendar**.
- 2 Touch the icon next to a calendar to change whether it is synchronized to the device and visible in **Calendar**.



Calendar events are synchronized to the device and visible in Calendar.



Calendar events are synchronized to the device but not visible in **Calendar**.



Calendar events are not synchronized to the device.

- 3 Touch **OK**.

Event reminders

If you set a reminder for an event, the upcoming event icon  appears in the notifications area of the status bar when the reminder time arrives.

To view, dismiss, or snooze a reminder

- 1 Drag the notification area of the status bar to open the **Notification** menu.

- 2 Touch the upcoming event name to display the event.

 **NOTE:** If you have other pending event reminders, these events will also appear on the screen.

- 3 Touch **Snooze all** to put off all event reminders for five minutes. Touch **Dismiss all** to turn off all event reminders. Press  to keep the reminders pending in the notification area of the status bar.

Clock

Your device can work as a desk alarm clock to display current time and date, local weather, and play picture slideshow and music.

Touch the Launcher button  → **Clock** .



-
- 1 Displays the first active alarm time.

 - 2 The current time and date.

 - 3 Touch to set the alarm.

 - 4 Touch to play the slideshow of the pictures stored on your device.

 - 5 Touch to start the Music application and choose the music to play.

 - 6 Touch to return to the Home screen.

 - 7
 - Displays the local weather.
 - Touch to start the News and Weather application to find more weather updates.



 - 8
 - Touch to turn the backlight down to the minimum level.
 - Touch and hold to turn off the backlight and only display the current time, date, and alarm time.

NOTE: To turn on the backlight, touch anywhere on the screen.

To set an alarm

You can set multiple alarms.

- 1 On the Clock main screen, touch .
- 2 On the **Alarms** screen, touch **Add alarm**.
- 3 The **Set alarm** menu opens with these settings:

Turn on alarm	Turn on the alarm that you have set on the device.
Time	Set the alarm time. Adjust the time by touching  or  , or touch the hour and minute fields to enter a time. Touch AM to change to PM or vice versa, then touch Set when done.
Repeat	Select the days you want the alarm to ring, then touch OK . NOTE: If you did not select any days for the alarm, Never appears to hint that your alarm will only go off once.
Ringtone	Select the alarm ringtone.
Vibrate	Select the check box if you want the device to vibrate when the alarm goes off.
Label	Give the alarm a name for a special event.

- 4 Touch **Done** to set the alarm.



NOTE: On the **Alarms** screen you can also add a new alarm by touching the Menu button  → **Add alarm**.

To temporarily disable an alarm

On the **Alarms** screen, clear the green bar of the alarm time you want to disable.

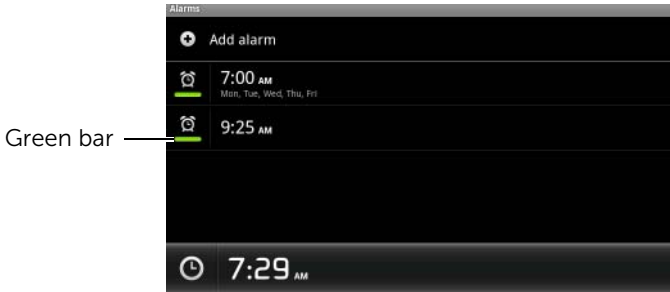

To delete an alarm



- 1 On the **Alarms** screen, touch the alarm time you want to delete.
- 2 On the **Set alarm** screen, touch **Delete**.

To enable the alarm in silent mode

You can choose if the alarm should ring when the device is in silent mode.

- 1 On the **Alarms** screen, touch the Menu button  → **Settings**.
- 2 Touch **Alarm in silent mode** to set if the alarm should ring when the device is in silent mode.









Calculator

- 1 Touch the Launcher button  → **Calculator**. The basic calculator panel opens.
- 2 Perform calculations by touching the corresponding buttons on the calculator panel; touch the **CLEAR** button to clear the displayed numbers or symbols.
- 3 To perform advanced calculations, flick the basic calculator panel away to the left and reveal the advanced panel, or touch the Menu button  → **Advanced panel**.

Sound Recorder

Open this application to record voice and sounds and then play them back. You can also set the recording as a ringtone for your device.

 **NOTE:** The sound recorder only supports recording in the amr format.

- 1 Touch the Launcher button  → **Sound Recorder** .
- 2 Touch  to start recording.
- 3 Touch  to end recording.
- 4 Touch  to start playback of the recording; touch  to stop playback.
- 5 Touch **Save this recording** to save the recording on the SD card.
- 6 To play back a sound recording again, touch the Launcher button  → **Music**  → **Songs**, then select a recording to play. For information about **Music**, see "Music" on page 126.

Synchronizing Your Dell Streak 7 Tablet and Computer Using Dell Mobile Sync

The Dell Mobile Sync (powered by Nero™) software allows you to copy or sync music, photos, videos, and Outlook contacts between your device and a computer.

 **NOTE:** The Dell Mobile Sync software is supported by Microsoft Windows XP (SP3), Windows Vista, and Windows 7 operating systems.

To install the Dell Mobile Sync software on your computer

- 1 Connect the supplied USB cable to your device and a computer. Wait for your computer to automatically install the device driver.

After the driver installation is complete, the Dell Mobile Sync installer may start automatically on computers running the Microsoft Windows XP (SP3) and Windows Vista operating systems.

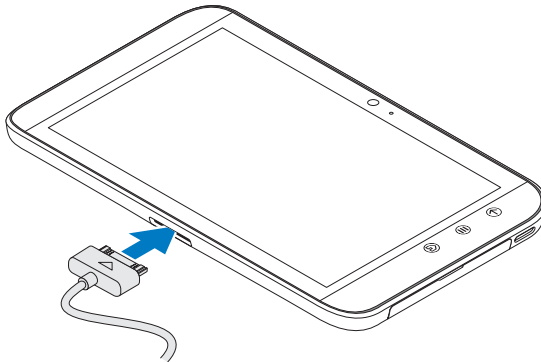

- 2 If the Dell Mobile Sync installer does not start automatically:
 - a Double-click the new **Removable Disk** that appears on your computer.
 - b Navigate to the **Dell Mobile Sync** folder on the removable disk.

- c Double-click the **InstallDellMSync.exe** file to start the installation.



NOTE: You can also download and install the Dell Mobile Sync software from support.dell.com/support/downloads.

To sync music, photos, videos, and Outlook contacts:





- 1 Ensure that the supplied USB cable is connected to your device and a computer.
- 2 Double-click the Dell Mobile Sync icon  on the Windows desktop. Your device appears under the **Devices** section in the Dell Mobile Sync software.
- 3 After the copy or sync is complete, disconnect the USB cable.



NOTE: For information about the Dell Mobile Sync software and to learn how to sync your device to a computer using Wi-Fi, see the documentation included in the Dell Mobile Sync software.

Troubleshooting

Problem	Possible causes	Possible solutions
PIN Code is blocked	You have entered an incorrect PIN code three consecutive times.	Contact your service provider. If the service provider provides the SIM card's PUK code, use the PUK code to unlock the SIM card.
System problems		
Battery does not charge	The battery or battery charger is damaged.	Contact the dealer.
	The device's temperature is below 0°C or higher than 45°C.	Adjust the battery charging environment to avoid extreme temperatures.
	Poor contact between the battery and charger.	Check all connectors to ensure that all connections have been properly made.
Unable to turn the device on.	The battery is empty.	Charge the device.
Shortened standby time	The duration of standby time is affected by your service provider's system configuration. The same device used with different service providers' systems does not have the same duration of standby time.	If you are located in an area where the network signal is weak, temporarily turn off your device.
	If you are not able to connect to the network, the device will continue to send out signals as it attempts to locate a base station. Doing this consumes battery charge and consequently shortens standby time.	Change your location to one where the network is accessible, or temporarily turn off your device.

Problem	Possible causes	Possible solutions
Messaging problems		
Unable to send or receive text messages.	Your device is in Airplane mode with no wireless connectivity.	Touch the Home button  → Menu button  → Settings → Wireless & networks → Clear the Airplane mode check box.
	The signal strength is not strong enough.	Try moving to a different location for better signal reception.
Unable to send or receive e-mail.	The Internet connection or the e-mail setting is not configured properly.	Check your network connection, and confirm with your e-mail service provider if your e-mail setting has been configured correctly.
Internet problems		
Unable to connect to the network.	Invalid SIM card.	Contact your service provider.
	You are not within the network's service area.	Check the service area with your service provider.
	Poor signal.	Move to an open space or if you are inside a building, move closer to a window.
	Your device is in Airplane mode with no wireless connectivity.	Touch the Home button  → Menu button  → Settings → Wireless & networks → Clear the Airplane mode check box.
Media problems		
Windows Media Player on my computer cannot play the sounds of the video captured using the device.	The device records video sounds in amr format, but Windows Media Player does not support amr decoding.	Play the video using a video player with the amr decoder, such as QuickTime.

Starting Your Device in the Safe Mode

If you find your device unusable because of an application you installed, try to start your device in the Safe mode. In the Safe mode, all 3rd-party applications are disabled and you can remove any problematic applications to continue using your device normally.

To enter the Safe mode, follow the steps below.

- 1 Make sure your device is off.
- 2 Press and hold the Power and Sleep/Wake button  to turn on your device.
- 3 While the operating system is starting up, the white DELL logo appears twice.







When you see the white DELL logo at the second time, touch and hold the Menu button  until "Safe mode" appears at the bottom of the screen.







NOTE: To exit the Safe mode, turn off your device and turn it on normally again.

If the device cannot power on due to system corruption, take either of these recovery actions:

Reset your device to the default state

- 1 Press and hold the power button  and then touch the **Power off** option on the screen to turn off the device.
- 2 Press and hold the volume up button .
- 3 Without releasing the volume up button, press and hold the power button , until the device turns on the configuration screen.
- 4 Press the volume up button  or the volume down button  to move the highlight bar on the screen to the **Factory Reset** option.
- 5 Press the power button  to start the reset process.
- 6 Wait for the device to reboot.

Start software recovery

- 1 Connect an SD card to your computer.
- 2 On your computer, go to **support.dell.com** and follow the instructions to download the software upgrade package to the SD card.
NOTE: The device only recognizes the software upgrade package as "Update.pkg". Rename the downloaded package to "Update.pkg" if it is not named so.
- 3 Disconnect the SD card from the computer and install the SD card into the device.
- 4 Follow steps 1 to 3 in **Reset your device to the default state** to turn on the configuration screen.
- 5 Press the volume up button  or the volume down button  to move the highlight bar to the **Software upgrade via Update.pkg on SD card** option, and press the power button  to confirm your selection.
- 6 Press the power button  to confirm and start software recovery.
- 7 Wait for the device to load files and reboot the system.

Index

A

- Airplane Mode, 57
- Alarm Clock, 132
- Android Market, 103
- Applications
 - Definition, 17
 - Erase data, 51
 - Navigate, 33
 - Recently used, 34
 - Shortcuts, 34

B

- Battery
 - Charge, 12
- Bluetooth, 121
- Button
 - Back, 8
 - Home, 9
 - Menu, 8
 - Power and Sleep/Wake, 8
 - Volume up/down, 7

C

- Calculator, 134
- Calendar, 129
- Camcorder, 119

- Camera, 118
 - Camcorder, 119
 - Shoot videos, 119
 - Take pictures, 118

Charging, 12

Connection

- Mobile networks, 54
- To a computer, 120
- Wi-Fi, 55

Contacts, 36

- Add, 36
- Sync, 38
- View, 37

Controls, 7

- Touch screen, 14

Customize, 108

D

- Data connection, 54
- Date, 111
- Dell Mobile Sync, 136
- Dell Stage
 - Desktop, 18
 - widgets, 21
- Device
 - Customize, 108
 - Overview, 7
 - Protect, 113

- Safe Mode, 140
- Settings, 51
- Setup, 11
- Turn off, 13
- Turn on, 13

Disable all connections, 57

Display settings, 108

E

E-mail, 65

Emergency software recovery, 141

Erase all data, 52

F

Facebook, 68

Force power off, 53

G

Gallery, 124

Gmail, 76

Google Account Setup, 76

Google Maps, 83

Google Maps Navigation, 94

Google Search, 49

Google Talk, 79

H

Home screen, 18

- Customize, 24

I

Internet

- Browse, 57
- Connection, 54

K

Keyboard, 46

L

Language, 112

M

Maps, 83

Messaging, 39

- Compose, 39
- Receive, 43

Mobile networks, 54

Music, 126

- Create a playlist, 128
- Playback, 127

N

Navigation, 94

News and Weather, 98

O

On-Screen Keyboard, 46

P

Pictures and videos, 124

PIN

Change, 117

Device, 115

Enable, 117

Places, 93

Pop-Up menu, 45

R

Recorder, 135

Ringtone, 109

S

Safe Mode, 140

Screen

Orientation, 17

Turn off/on, 13

Screen Unlock Pattern, 113

Create, 113

Disable/change, 114

Settings, 115

SD card, 120

Format, 51

Insert, 11

Remove, 51

Set as USB drive, 120

Turn off USB storage, 121

Unmount, 51

Search, 49

Settings

Date and time, 111

Display, 108

Language, 112

Sound and ringtone, 109

Shortcuts, 34

Add, 24

Definition, 18

SIM card

Insert, 11

Software

Recovery, 141

Sound, 109

Stage widgets, 21

Status bar, 29

Icons, 30

Synchronize Google Data, 107

Synchronize with Computer

Use Dell Mobile Sync, 136

T

Text message, 39

Time, 111

Time zone, 111

Touch screen, 14
Troubleshooting, 138
Twitter, 72

V

Voice Search, 50

W

Web

- Applications, 68
- Bookmarks, 62

Widgets

- Add, 26
- Definition, 17
- Google Search, 49

Wi-Fi, 55

Y

YouTube, 100